

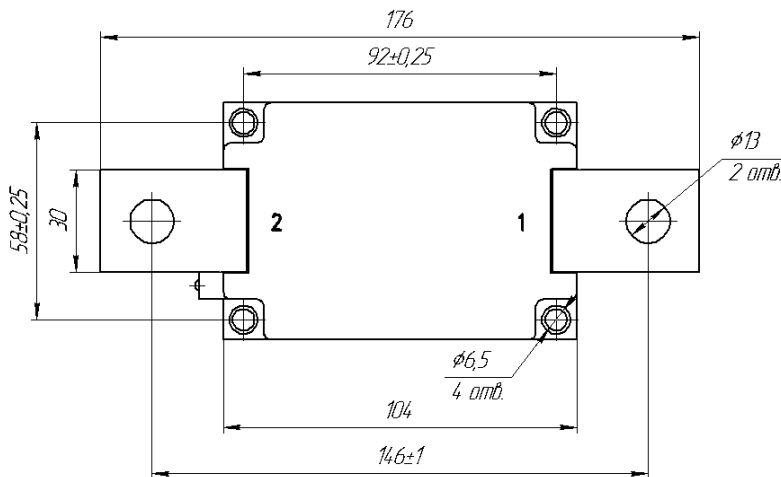
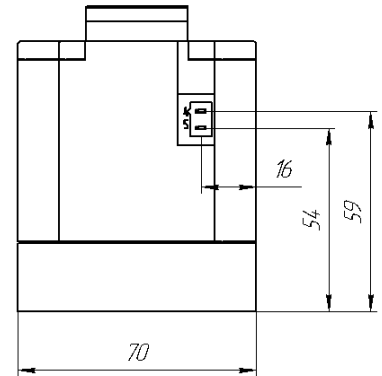
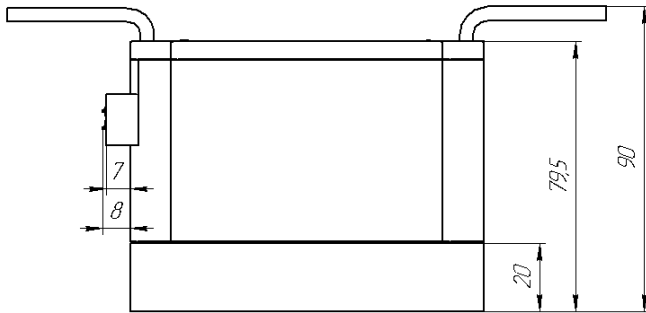
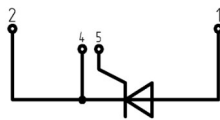


Electrically isolated base plate  
Industrial standard package  
Simplified mechanical design, rapid assembly  
Pressure contact

**Single Thyristor Module  
For Phase Control  
MT1-800-18-E**

Mean on-state current			$I_{TAV}$	800 A				
Repetitive peak off-state voltage			$V_{DRM}$	1000...1800 V				
Repetitive peak reverse voltage			$V_{RRM}$					
Turn-off time			$t_q$	250 $\mu$ s				
$V_{DRM}, V_{RRM}, V$	1000	1100	1200	1300	1400	1500	1600	1800
Voltage code	10	11	12	13	14	15	16	18
$T_j, ^\circ C$	-40...+130							

**MT1**



## MAXIMUM ALLOWABLE RATINGS

Symbols and parameters		Units	Values	Test conditions
<b>ON-STATE</b>				
$I_{TAV}$	Maximum allowable mean on-state current	A	800 901	$T_c=91\text{ }^\circ\text{C}$ ; $T_c=85\text{ }^\circ\text{C}$ ; 180° half-sine wave; 50 Hz
$I_{TRMS}$	RMS on-state current	A	1256	$T_c=91\text{ }^\circ\text{C}$ ; 180° half-sine wave; 50 Hz
$I_{TSM}$	Surge on-state current	kA	42.0 48.0	$T_j=T_{j\text{ max}}$ $T_j=25\text{ }^\circ\text{C}$ 180° half-sine wave; $t_p=10\text{ ms}$ ; single pulse; $V_D=V_R=0\text{ V}$ ; Gate pulse: $I_G=2\text{ A}$ ; $V_G=20\text{ V}$ ; $t_{GP}=500\text{ }\mu\text{s}$ ; $di_G/dt=1\text{ A}/\mu\text{s}$
			44.0 51.0	$T_j=T_{j\text{ max}}$ $T_j=25\text{ }^\circ\text{C}$ 180° half-sine wave; $t_p=8.3\text{ ms}$ ; single pulse; $V_D=V_R=0\text{ V}$ ; Gate pulse: $I_G=2\text{ A}$ ; $V_G=20\text{ V}$ ; $t_{GP}=500\text{ }\mu\text{s}$ ; $di_G/dt=1\text{ A}/\mu\text{s}$
$I^2t$	Safety factor	$\text{A}^2\text{s}\cdot 10^3$	8800 11500	$T_j=T_{j\text{ max}}$ $T_j=25\text{ }^\circ\text{C}$ 180° half-sine wave; $t_p=10\text{ ms}$ ; single pulse; $V_D=V_R=0\text{ V}$ ; Gate pulse: $I_G=2\text{ A}$ ; $V_G=20\text{ V}$ ; $t_{GP}=500\text{ }\mu\text{s}$ ; $di_G/dt=1\text{ A}/\mu\text{s}$
			8000 10700	$T_j=T_{j\text{ max}}$ $T_j=25\text{ }^\circ\text{C}$ 180° half-sine wave; $t_p=8.3\text{ ms}$ ; single pulse; $V_D=V_R=0\text{ V}$ ; Gate pulse: $I_G=2\text{ A}$ ; $V_G=20\text{ V}$ ; $t_{GP}=500\text{ }\mu\text{s}$ ; $di_G/dt=1\text{ A}/\mu\text{s}$
<b>BLOCKING</b>				
$V_{DRM}, V_{RRM}$	Repetitive peak off-state and Repetitive peak reverse voltages	V	1000...1800	$T_{j\text{ min}} < T_j < T_{j\text{ max}}$ ; 180° half-sine wave; 50 Hz; Gate open
$V_{DSM}, V_{RSM}$	Non-repetitive peak off-state and Non-repetitive peak reverse voltages	V	1100...1900	$T_{j\text{ min}} < T_j < T_{j\text{ max}}$ ; 180° half-sine wave; single pulse; Gate open
$V_D, V_R$	Direct off-state and Direct reverse voltages	V	$0.6\cdot V_{DRM}$ $0.6\cdot V_{RRM}$	$T_j=T_{j\text{ max}}$ ; Gate open
<b>TRIGGERING</b>				
$I_{FGM}$	Peak forward gate current	A	8	$T_j=T_{j\text{ max}}$
$V_{RGM}$	Peak reverse gate voltage	V	5	
$P_G$	Gate power dissipation	W	4	$T_j=T_{j\text{ max}}$ for DC gate current
<b>SWITCHING</b>				
$(di_T/dt)_{\text{crit}}$	Critical rate of rise of on-state current non-repetitive ( $f=1\text{ Hz}$ )	$\text{A}/\mu\text{s}$	630	$T_j=T_{j\text{ max}}$ ; $V_D=0.67\cdot V_{DRM}$ ; $I_{TM}=2200\text{ A}$ ; Gate pulse: $I_G=2\text{ A}$ ; $V_G=20\text{ V}$ ; $t_{GP}=50\text{ }\mu\text{s}$ ; $di_G/dt=2\text{ A}/\mu\text{s}$
<b>THERMAL</b>				
$T_{\text{stg}}$	Storage temperature	$^\circ\text{C}$	-40...+50	
$T_j$	Operating junction temperature	$^\circ\text{C}$	-40...+130	
$T_{c\text{ op}}$	Operating temperature	$^\circ\text{C}$	-40...+125	
<b>MECHANICAL</b>				
a	Acceleration under vibration	$\text{m}/\text{s}^2$	50	

## CHARACTERISTICS

Symbols and parameters		Units	Values	Conditions	
<b>ON-STATE</b>					
$V_{TM}$	Peak on-state voltage, max	V	1.45	$T_j=25\text{ }^\circ\text{C}; I_{TM}=2500\text{ A}$	
$V_{T(TO)}$	On-state threshold voltage, max	V	0.834	$T_j=T_{j\text{ max}};$	
$r_T$	On-state slope resistance, max	m $\Omega$	0.187	$0.5\pi I_{TAV} < I_T < 1.5\pi I_{TAV}$	
$I_L$	Latching current, max	mA	1500	$T_j=25\text{ }^\circ\text{C}; V_D=12\text{ V};$ Gate pulse: $I_G=I_{FGM}; V_G=20\text{ V};$ $t_{GP}=500\text{ }\mu\text{s}; di_G/dt=1\text{ A}/\mu\text{s}$	
$I_H$	Holding current, max	mA	300	$T_j=25\text{ }^\circ\text{C};$ $V_D=12\text{ V};$ Gate open	
<b>BLOCKING</b>					
$I_{DRM}, I_{RRM}$	Repetitive peak off-state and Repetitive peak reverse currents, max	mA	150 4.00	$T_j=T_{j\text{ max}}$ $T_j=25\text{ }^\circ\text{C}$	$V_D=V_{DRM}; V_R=V_{RRM}$
$(dv_D/dt)_{crit}$	Critical rate of rise of off-state voltage <sup>1)</sup> , min	V/ $\mu\text{s}$	200, 320, 500, 1000, 1600, 2000, 2500	$T_j=T_{j\text{ max}};$ $V_D=0.67\cdot V_{DRM};$ Gate open	
<b>TRIGGERING</b>					
$V_{GT}$	Gate trigger direct voltage, max	V	3.00 2.50 1.50	$T_j=T_{j\text{ min}}$ $T_j=25\text{ }^\circ\text{C}$ $T_j=T_{j\text{ max}}$	$V_D=12\text{ V}; I_D=3\text{ A};$ Direct gate current
$I_{GT}$	Gate trigger direct current, max	mA	400 250 150	$T_j=T_{j\text{ min}}$ $T_j=25\text{ }^\circ\text{C}$ $T_j=T_{j\text{ max}}$	
$V_{GD}$	Gate non-trigger direct voltage, min	V	0.50	$T_j=T_{j\text{ max}};$ $V_D=0.67\cdot V_{DRM};$	
$I_{GD}$	Gate non-trigger direct current, min	mA	80.00	Direct gate current	
<b>SWITCHING</b>					
$t_{gd}$	Delay time, max	$\mu\text{s}$	0.90	$T_j=25\text{ }^\circ\text{C}; V_D=1000\text{ V}; I_{TM}=I_{TAV};$ $di/dt=200\text{ A}/\mu\text{s};$	
$t_{gt}$	Turn-on time, max	$\mu\text{s}$	2.00	Gate pulse: $I_G=2\text{ A}; V_G=20\text{ V};$ $t_{GP}=50\text{ }\mu\text{s}; di_G/dt=2\text{ A}/\mu\text{s}$	
$t_q$	Turn-off time <sup>2)</sup> , max	$\mu\text{s}$	250	$dv_D/dt=50\text{ V}/\mu\text{s}; T_j=T_{j\text{ max}}; I_{TM}=I_{TAV};$ $di_R/dt=-10\text{ A}/\mu\text{s}; V_R=100\text{ V};$ $V_D=0.67\cdot V_{DRM}$	
$Q_{rr}$	Total recovered charge, max	$\mu\text{C}$	3140	$T_j=T_{j\text{ max}}; I_{TM}=I_{TAV};$	
$t_{rr}$	Reverse recovery time, max	$\mu\text{s}$	33	$di_R/dt=-10\text{ A}/\mu\text{s};$	
$I_{rr}$	Reverse recovery current, max	A	190	$V_R=100\text{ V}$	
<b>THERMAL</b>					
$R_{thjc}$	Thermal resistance, junction to case			180° half-sine wave, 50 Hz	
	per module	$^\circ\text{C}/\text{W}$	0.0400		
$R_{thch}$	Thermal resistance, case to heatsink				
	per module	$^\circ\text{C}/\text{W}$	0.0100		
<b>INSULATION</b>					
$V_{ISOL}$	Insulation test voltage	kV	3.00	Sine wave, 50 Hz; RMS	t=60 sec
			3.60		t=1 sec
<b>MECHANICAL</b>					
$M_1$	Mounting torque (M6) <sup>3)</sup>	Nm	6.00	Tolerance $\pm 15\%$	
$M_2$	Terminal connection torque (M12) <sup>3)</sup>	Nm	18.00	Tolerance $\pm 15\%$	
m	Weight, max	g	2250		

**PART NUMBERING GUIDE**

MT	1	-	800	-	18	-	A2	M2	-	E	-	N
1	2		3		4		5	6		7		8

1. MT - Thyristor module
2. Circuit Schematic
3. Average On-state Current, A
4. Voltage Code
5. Critical rate of rise of off-state voltage
6. Group of turn-off time ( $dv_D/dt=50 \text{ V}/\mu\text{s}$ )
7. Package Type (M.E)
8. Ambient Conditions:  
N – Normal

**NOTES**

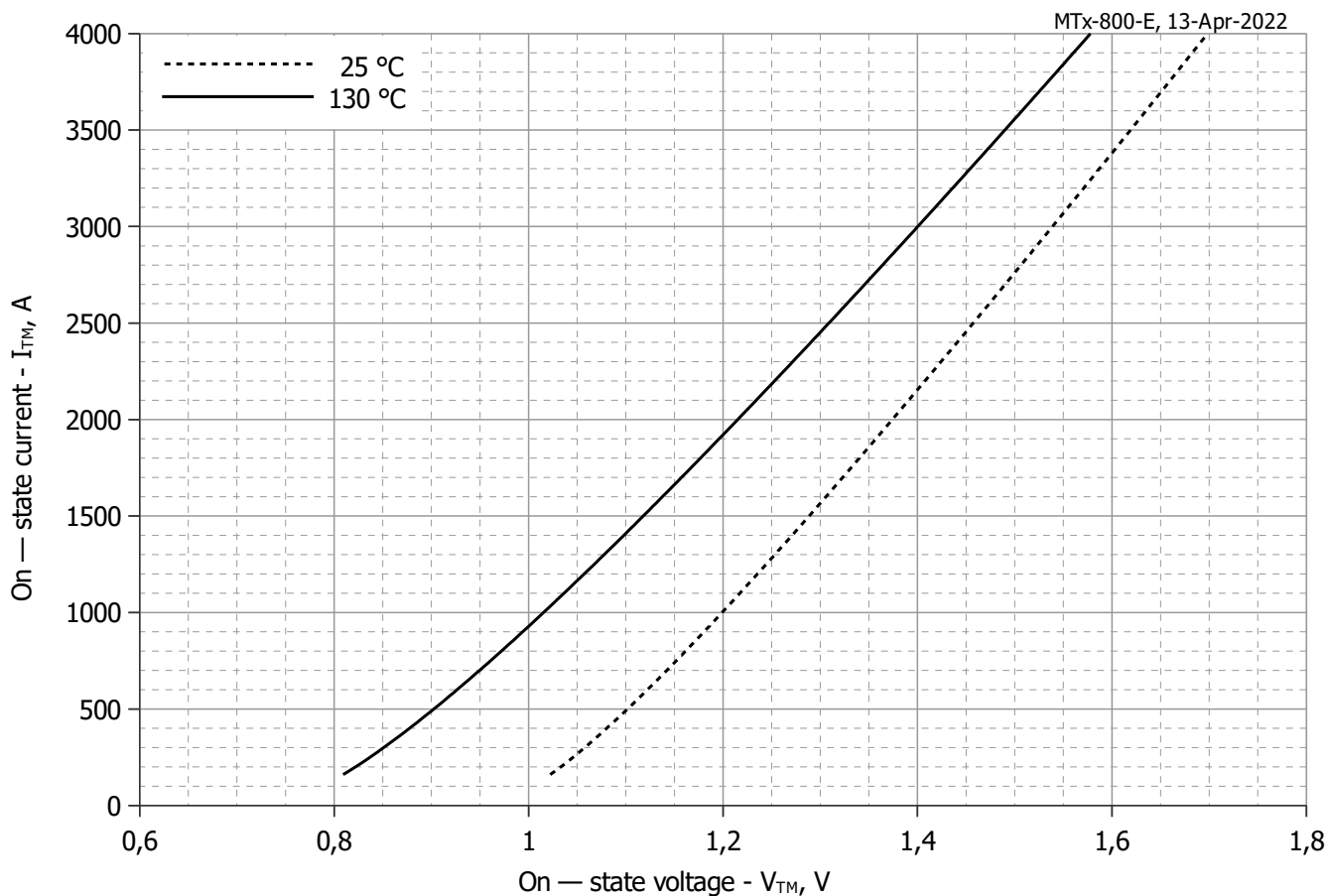
1) Critical rate of rise of off-state voltage

Symbol of Group	P2	K2	E2	A2	T1	P1	M1
$(dv_D/dt)_{crit}, \text{ V}/\mu\text{s}$	200	320	500	1000	1600	2000	2500

2) Turn-off time ( $dv_D/dt=50 \text{ V}/\mu\text{s}$ )

Symbol of Group	M2
$t_{qf}, \mu\text{s}$	250

3) The screws must be lubricated



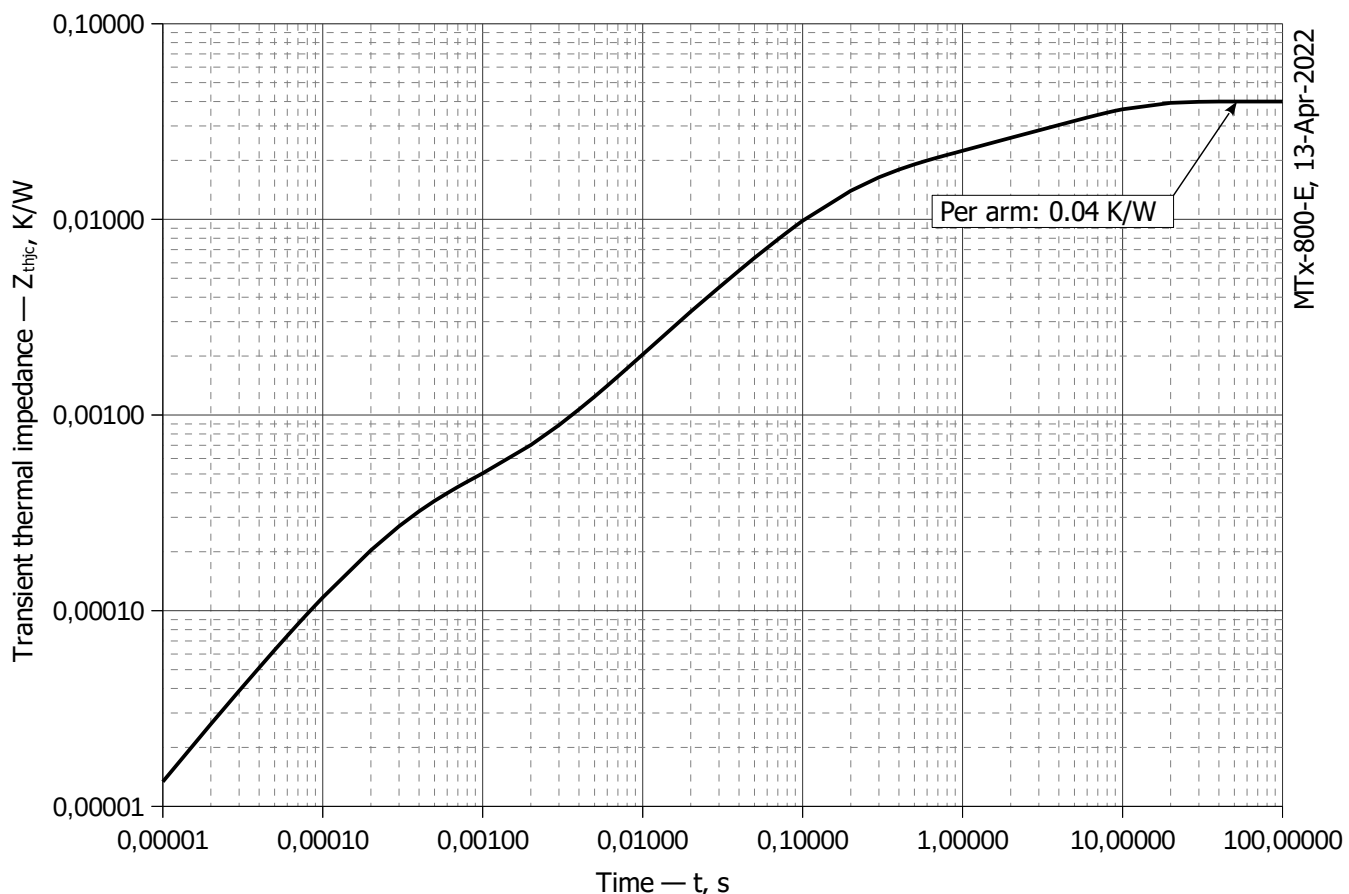
**Fig 1 – On-state characteristics of Limit device**

Analytical function for On-state characteristic:

$$V_T = A + B \cdot i_T + C \cdot \ln(i_T + 1) + D \cdot \sqrt{i_T}$$

	Coefficients for max curves	
	$T_j = 25^\circ\text{C}$	$T_j = T_{j,max}$
<b>A</b>	0.93815531	0.72539983
<b>B</b>	0.00013321	0.00013743
<b>C</b>	0.00505674	0.00041170
<b>D</b>	0.00293182	0.00473380

**On-state characteristic model (see Fig. 1)**



**Fig 2 – Transient thermal impedance  $Z_{thjc}$  vs. time  $t$**

Analytical function for Transient thermal impedance junction to case  $Z_{thjc}$  for DC:

$$Z_{thjc} = \sum_{i=1}^n R_i \left( 1 - e^{-\frac{t}{\tau_i}} \right)$$

Where  $i = 1$  to  $n$ ,  $n$  is the number of terms in the series.

$t$  = Duration of heating pulse in seconds.

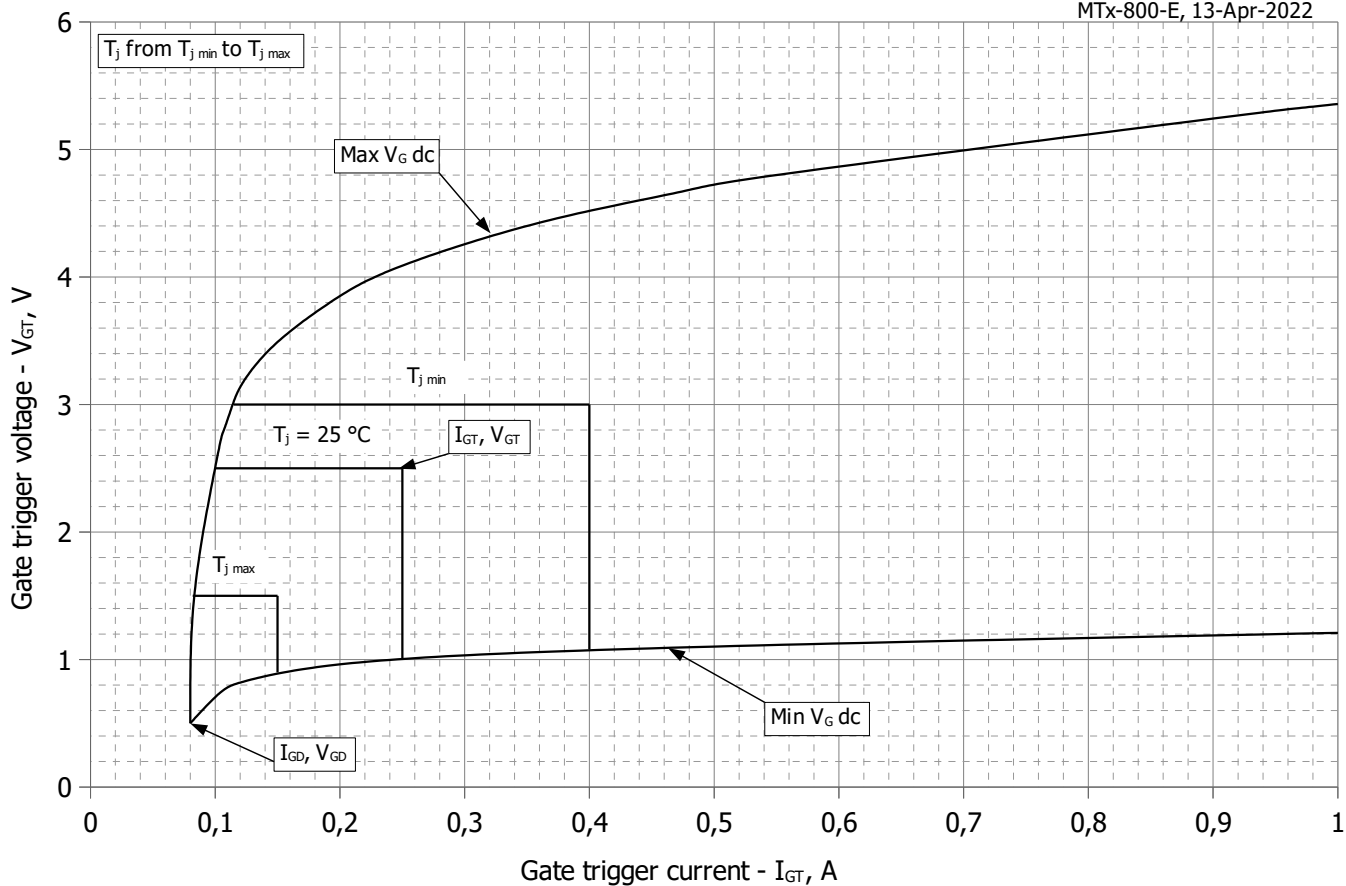
$Z_{thjc}$  = Thermal resistance at time  $t$ .

$R_i$  = Amplitude of  $p_{th}$  term.

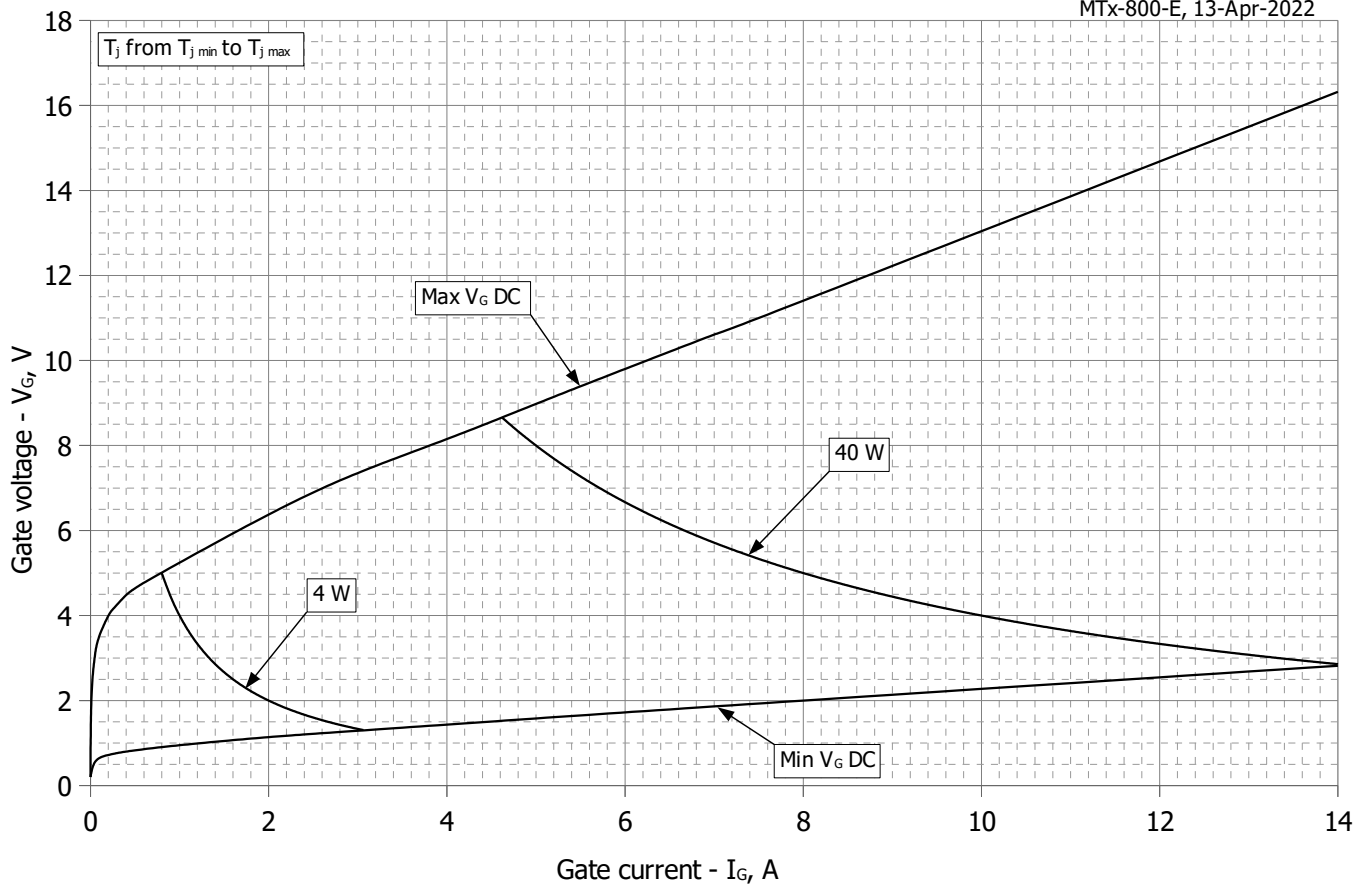
$\tau_i$  = Time constant of  $r_{th}$  term.

<b>i</b>	<b>1</b>	<b>2</b>	<b>3</b>	<b>4</b>	<b>5</b>	<b>6</b>
<b><math>R_i</math> K/W</b>	0.02251	0.005931	0.009502	0.004252	0.001006	0.0003132
<b><math>\tau_i</math> s</b>	5.887	0.7389	0.1616	0.08215	0.01267	0.0002712

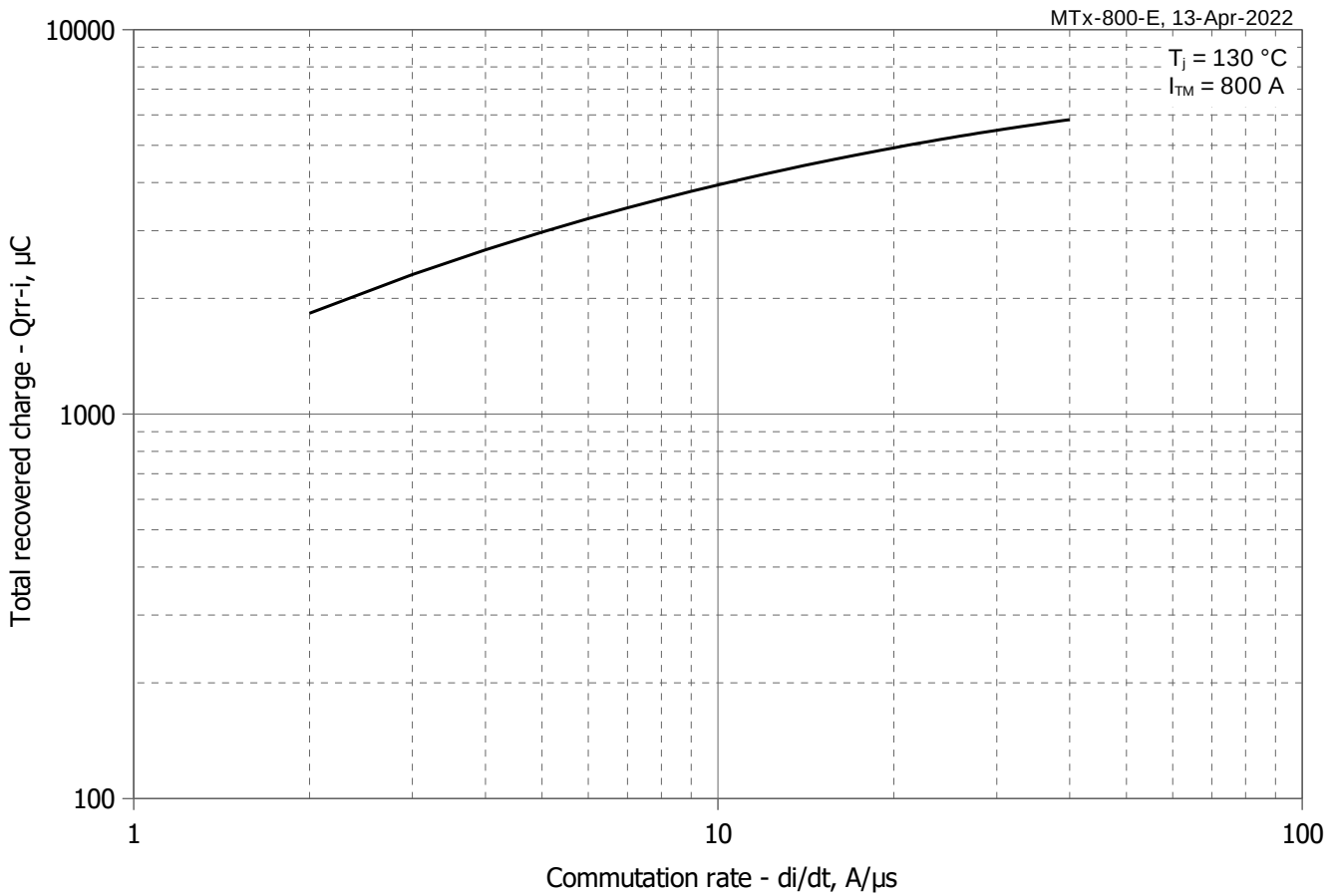
**Transient thermal impedance junction to case  $Z_{thjc}$  model (see Fig. 2)**



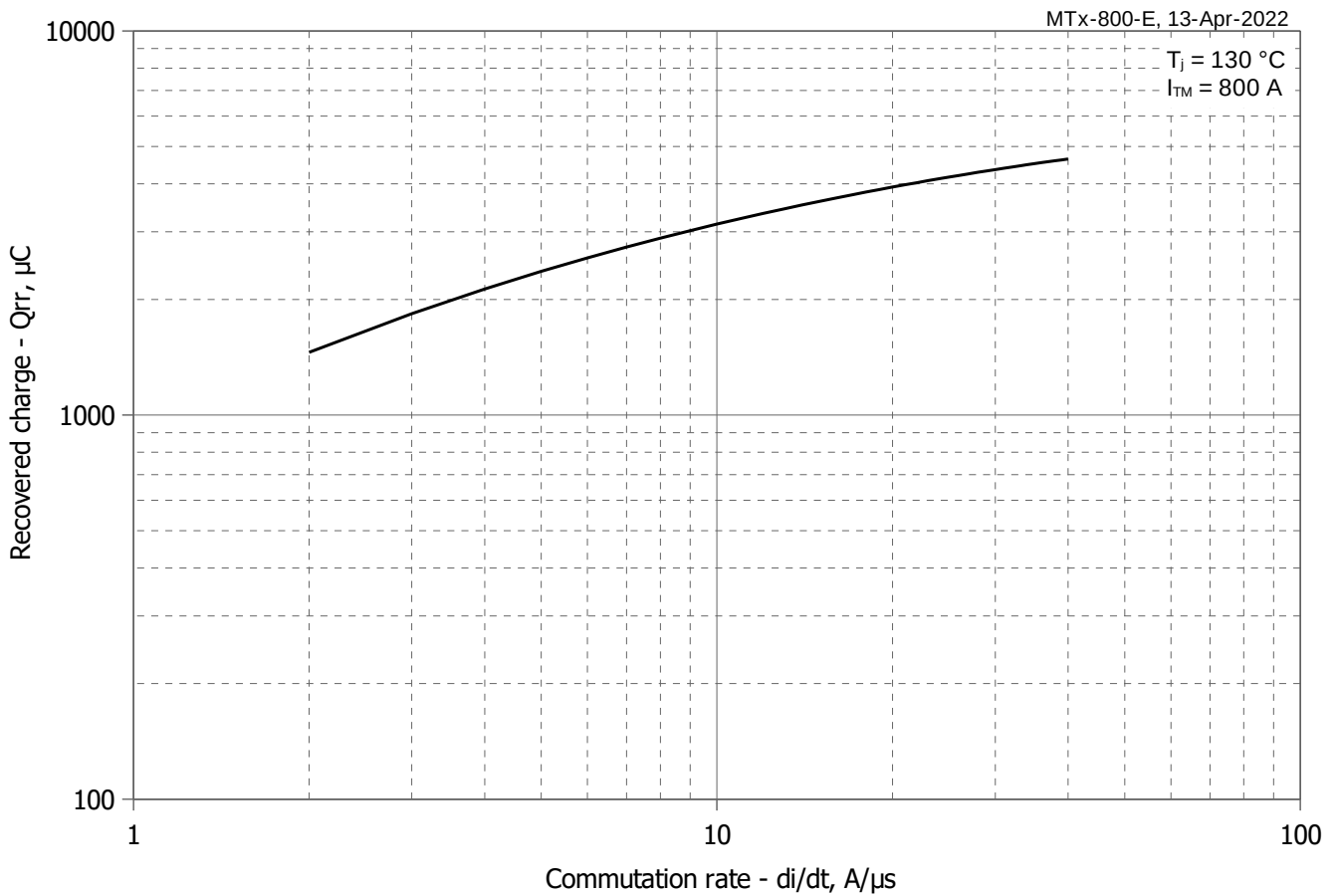
**Fig 3 – Gate characteristics – Trigger limits**



**Fig 4 - Gate characteristics – Power curves**

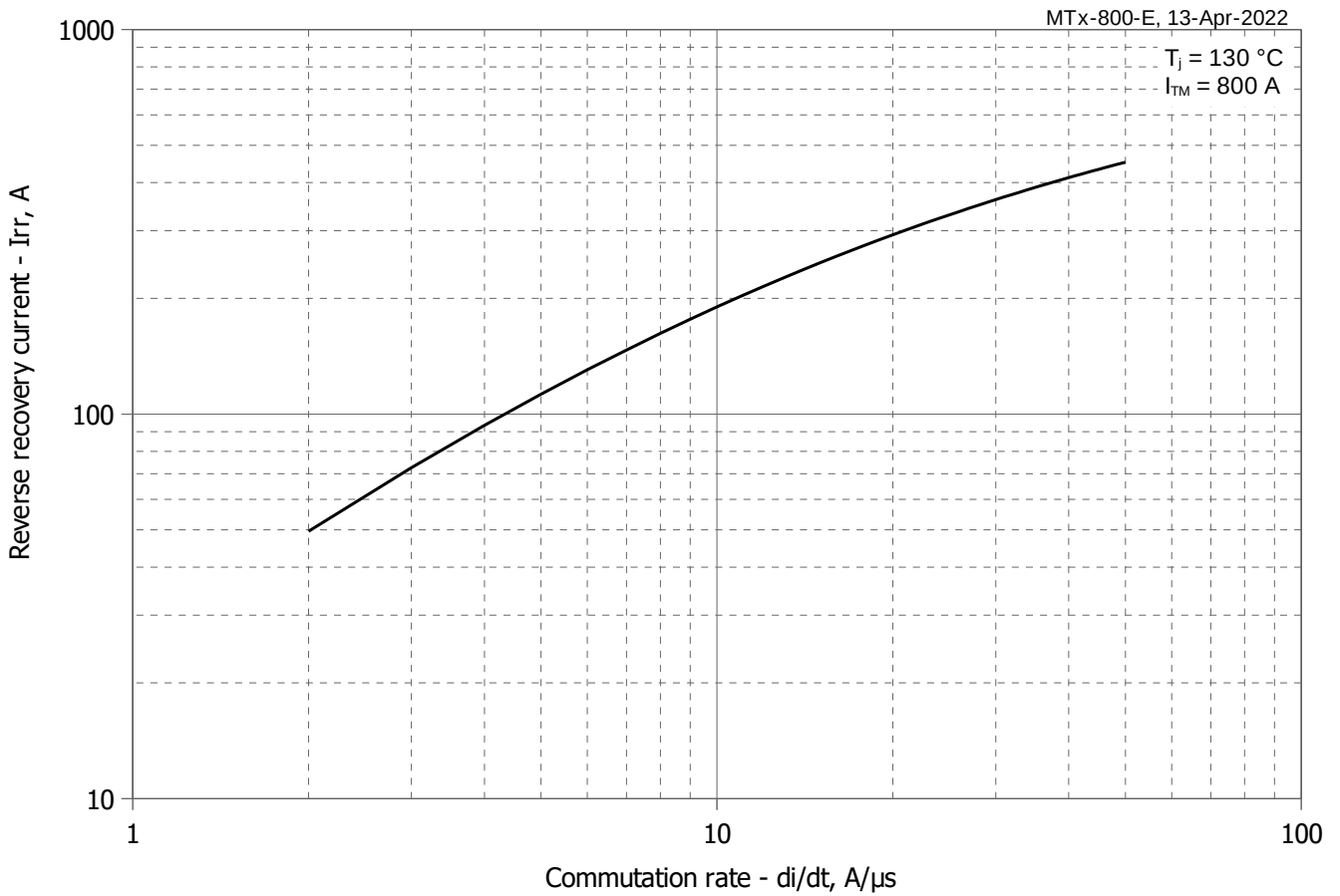


**Fig 5 – Maximum recovered charge  $Q_{rr-i}$  (integral) vs. commutation rate  $di_R/dt$**

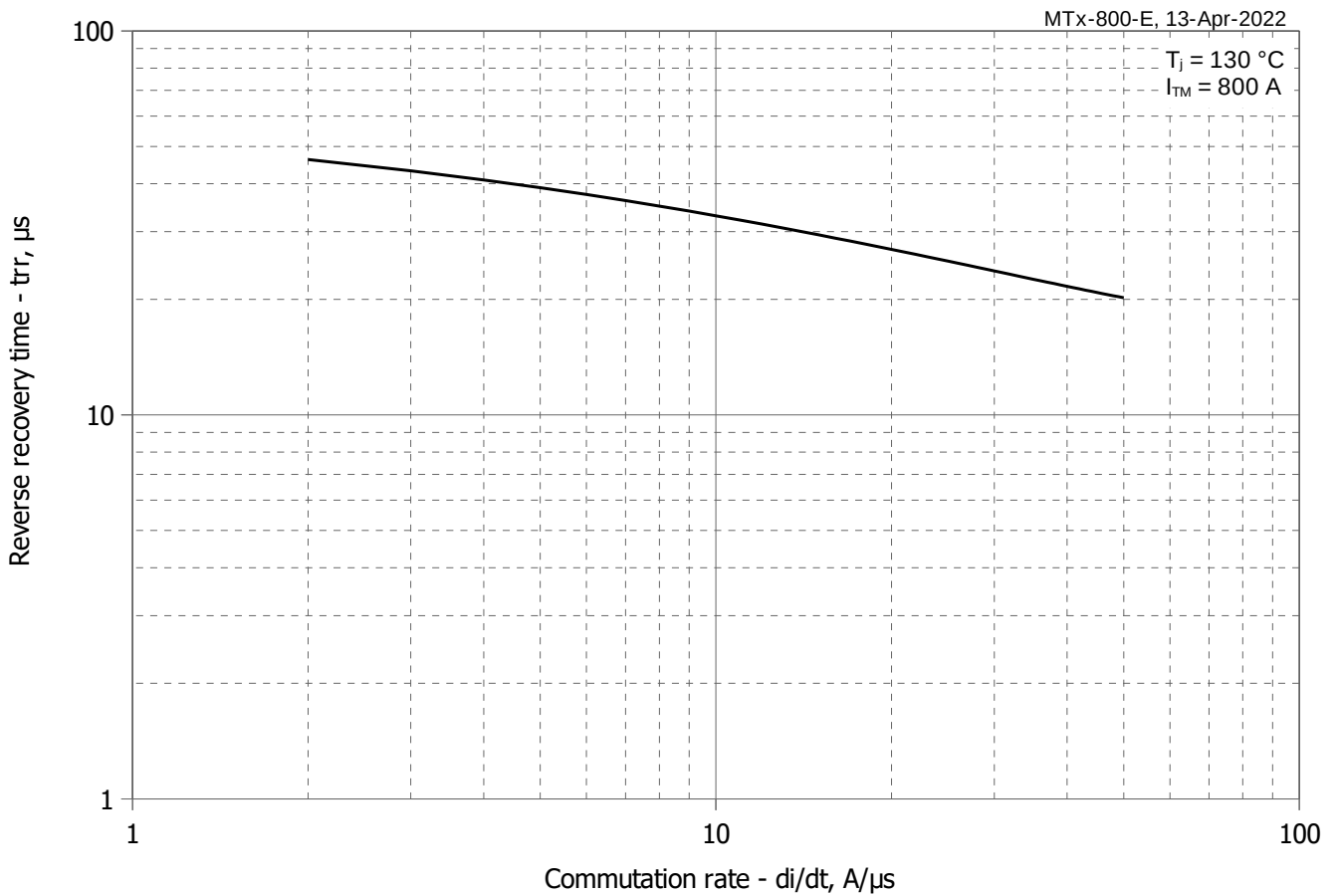


**Fig 6 – Maximum recovered charge  $Q_{rr}$  vs. commutation rate  $di_R/dt$  (25% chord)**

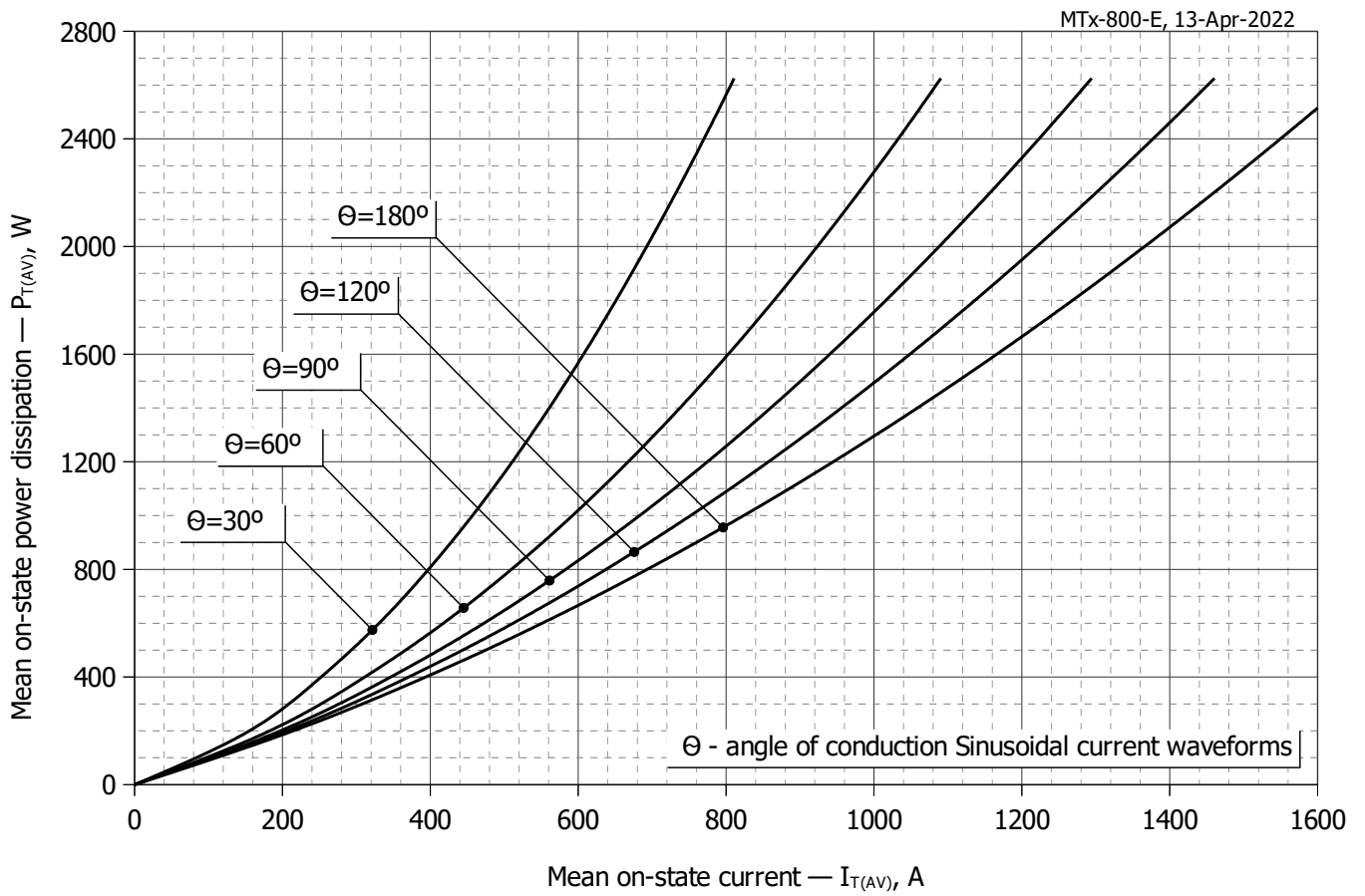




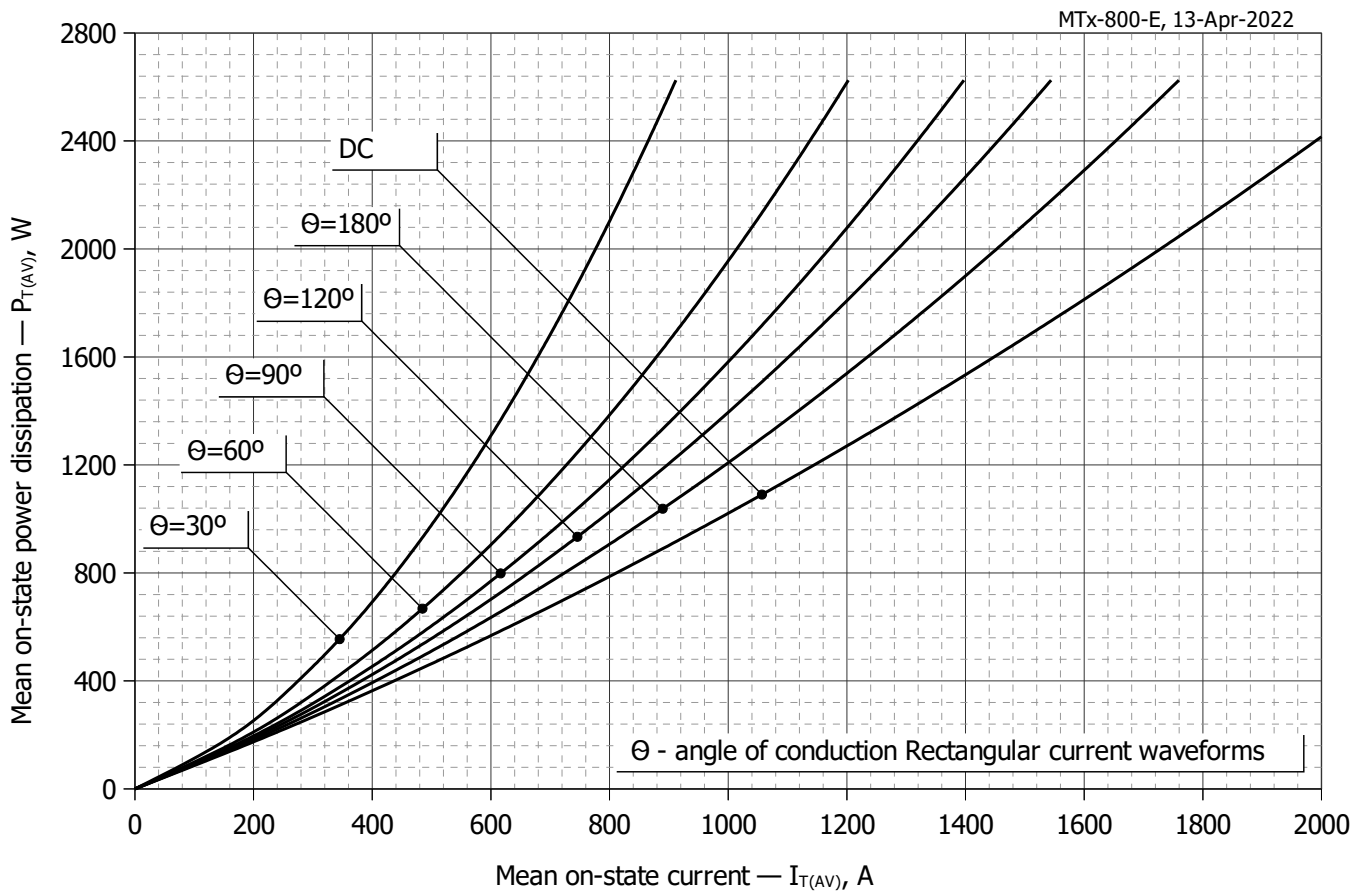
**Fig 7 – Maximum reverse recovery current  $I_{rr}$  vs. commutation rate  $di_R/dt$**



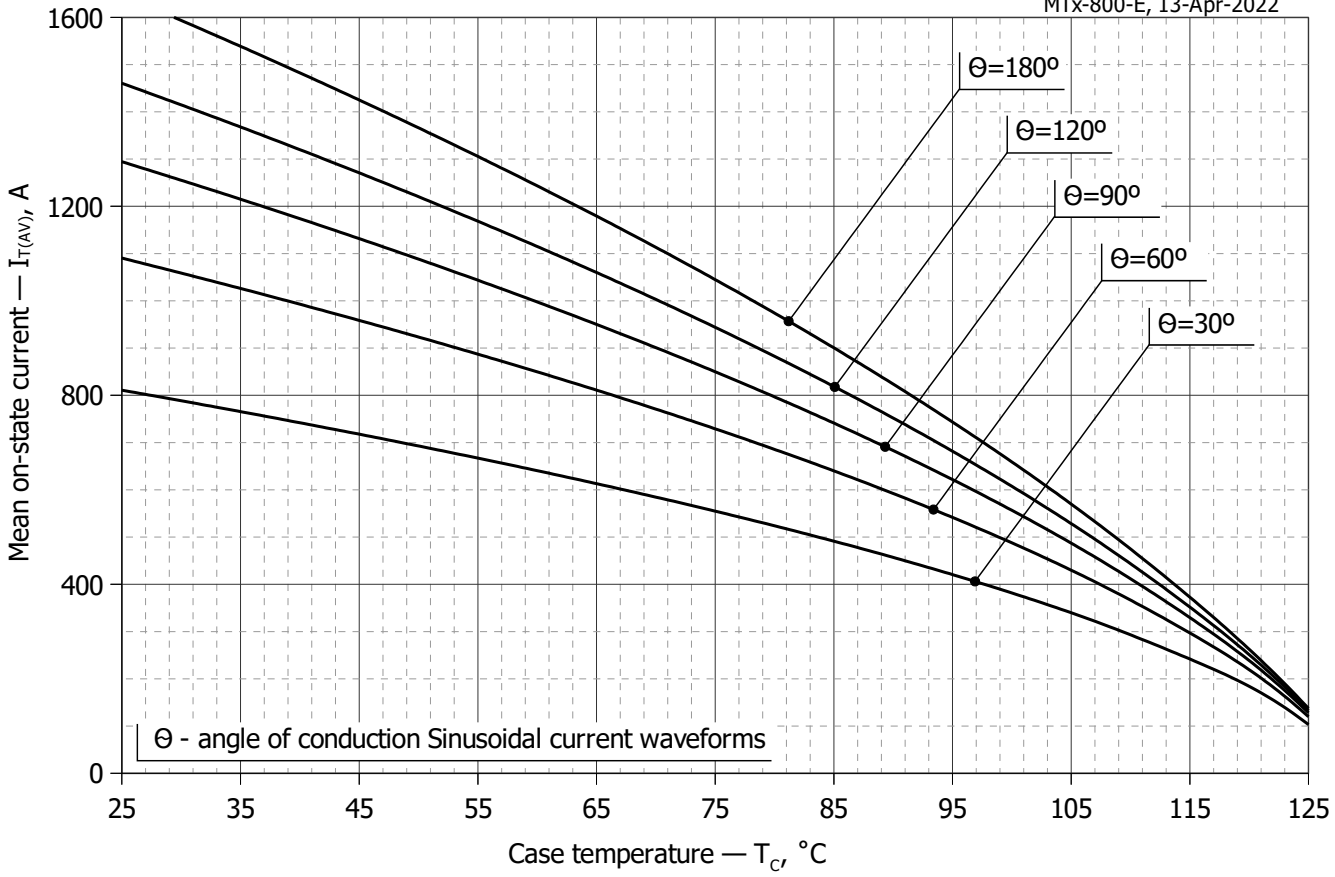
**Fig 8 – Maximum recovery time  $t_{rr}$  vs. commutation rate  $di_R/dt$  (25% chord)**



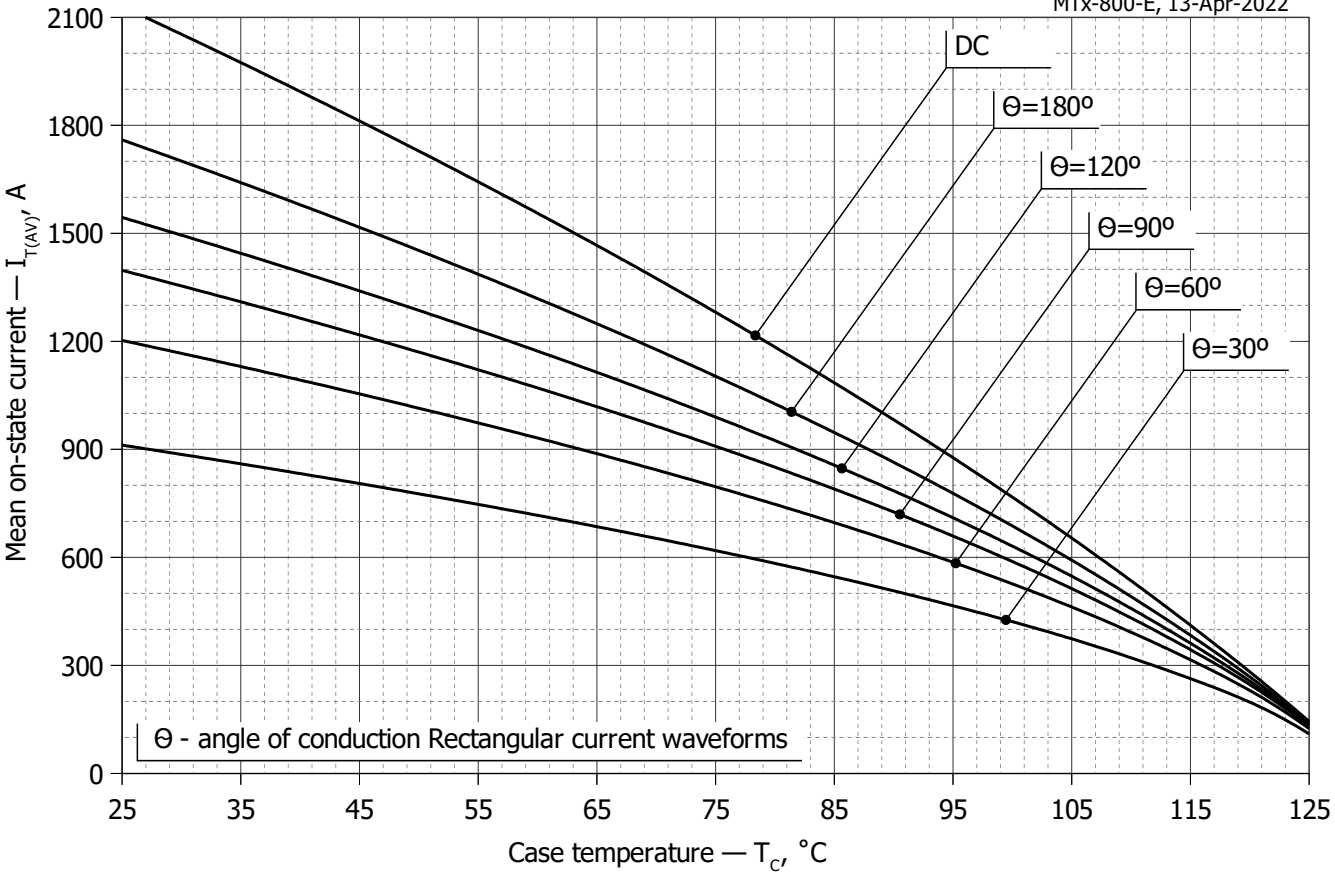
**Fig. 9 - Mean on-state power dissipation  $P_{TAV}$  vs. mean on-state current  $I_{TAV}$  for sinusoidal current waveforms at different conduction angles ( $f=50\text{Hz}$ )**



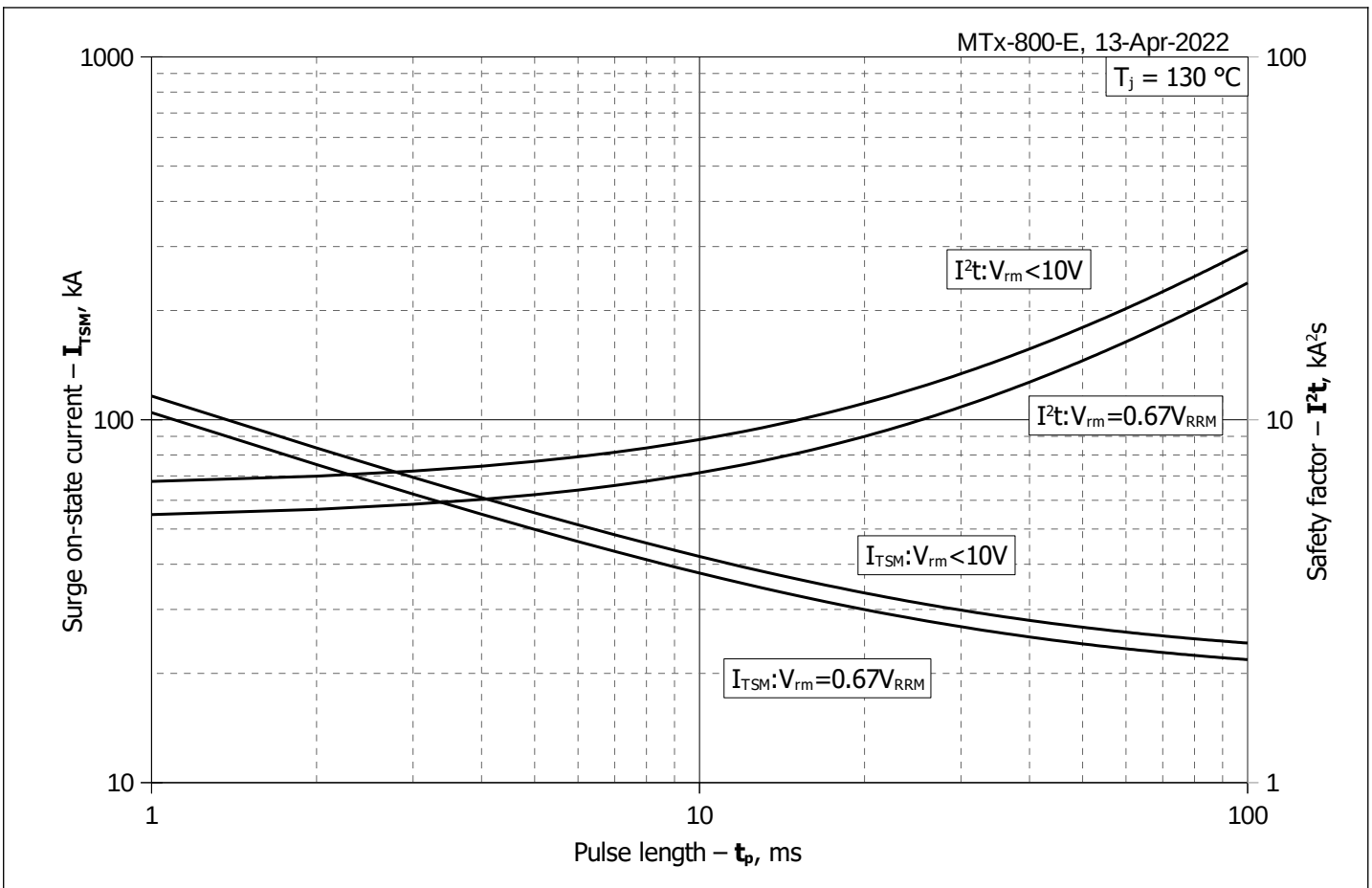
**Fig. 10 - Mean on-state power dissipation  $P_{TAV}$  vs. mean on-state current  $I_{TAV}$  for rectangular current waveforms at different conduction angles and for DC ( $f=50\text{Hz}$ )**



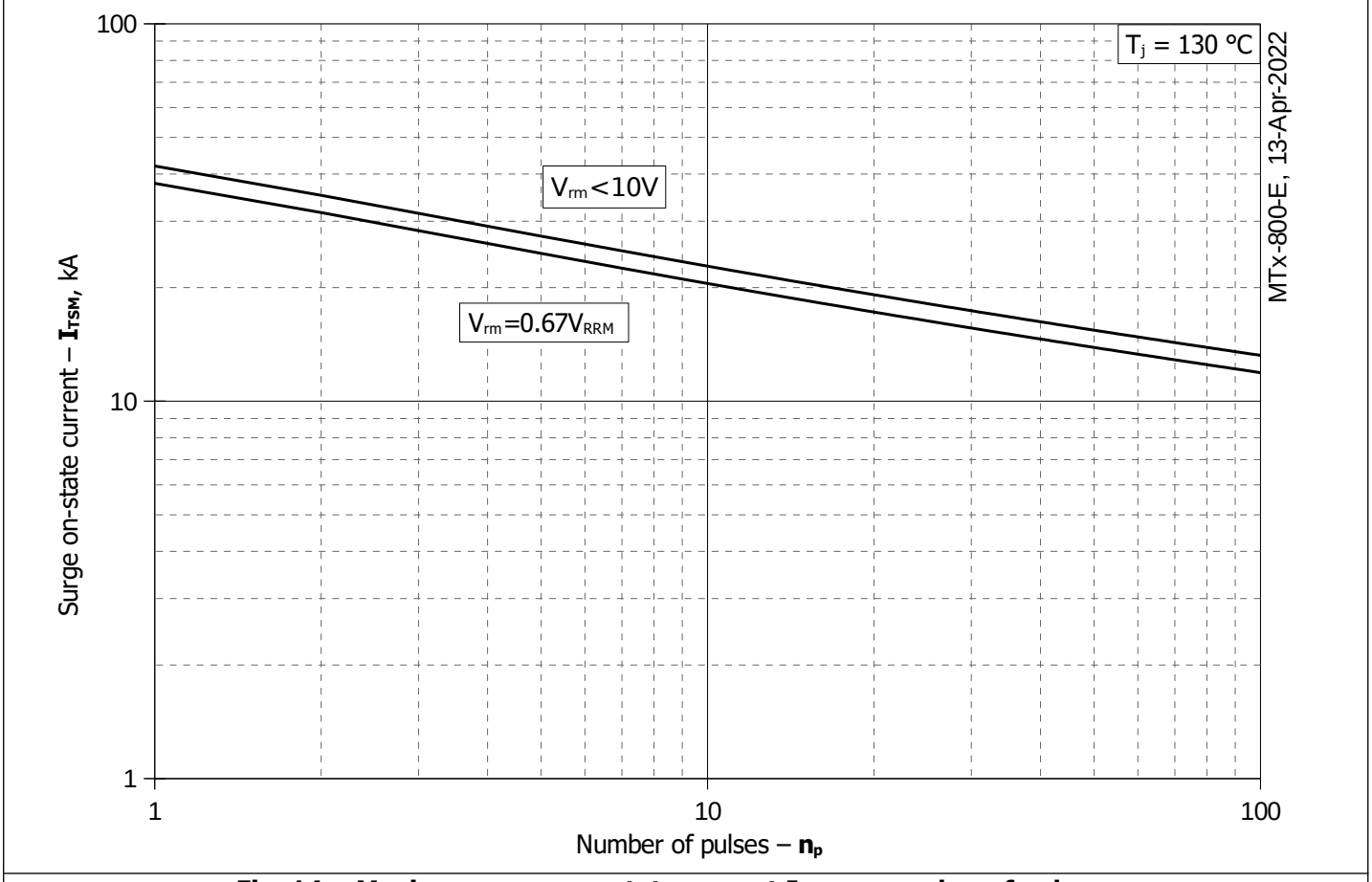
**Fig. 11 – Mean on-state current  $I_{TAV}$  vs. case temperature  $T_c$  for sinusoidal current waveforms at different conduction angles ( $f=50\text{Hz}$ )**



**Fig. 12 - Mean on-state current  $I_{TAV}$  vs. case temperature  $T_c$  for rectangular current waveforms at different conduction angles and for DC ( $f=50\text{Hz}$ )**



**Fig. 13 – Maximum surge on-state current  $I_{TSM}$  and safety factor  $I^2t$  vs. pulse length  $t_p$**



**Fig. 14 - Maximum surge on-state current  $I_{TSM}$  vs. number of pulses  $n_p$**