



Electrically isolated base plate
Industrial standard package
Simplified mechanical design, rapid assembly
Pressure contact

**Single Thyristor Module
For Phase Control
MT1-830-18-E**

Mean on-state current			I_{TAV}	830 A				
Repetitive peak off-state voltage			V_{DRM}	1000...1800 V				
Repetitive peak reverse voltage			V_{RRM}					
Turn-off time			t_q	250 μs				
V_{DRM}, V_{RRM}, V	1000	1100	1200	1300	1400	1500	1600	1800
Voltage code	10	11	12	13	14	15	16	18
$T_j, ^\circ C$	-40...+130							

MT1

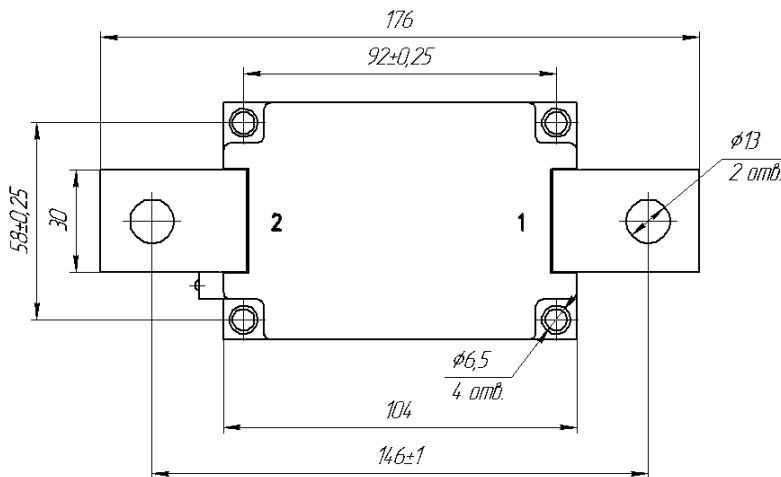
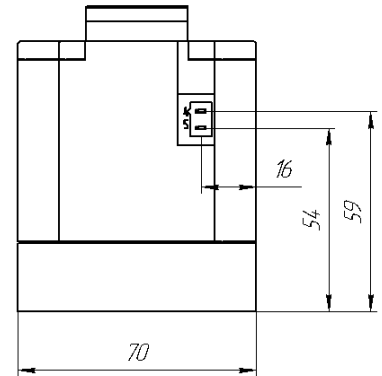
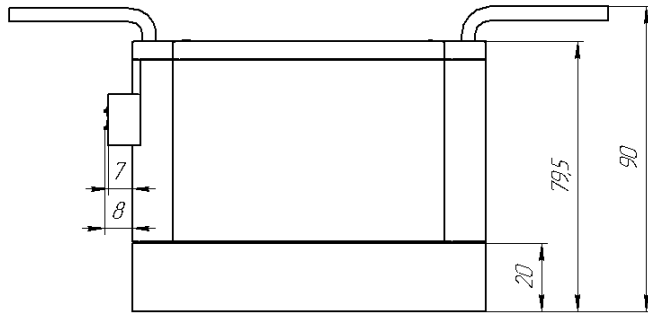
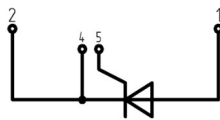

MAXIMUM ALLOWABLE RATINGS

Symbols and parameters		Units	Values	Test conditions
ON-STATE				
I_{TAV}	Maximum allowable mean on-state current	A	830 901	$T_c=89\text{ }^\circ\text{C}$; $T_c=85\text{ }^\circ\text{C}$; 180° half-sine wave; 50 Hz
I_{TRMS}	RMS on-state current	A	1303	$T_c=89\text{ }^\circ\text{C}$; 180° half-sine wave; 50 Hz
I_{TSM}	Surge on-state current	kA	42.0 48.0	$T_j=T_{j\text{ max}}$ $T_j=25\text{ }^\circ\text{C}$ 180° half-sine wave; $t_p=10\text{ ms}$; single pulse; $V_D=V_R=0\text{ V}$; Gate pulse: $I_G=2\text{ A}$; $V_G=20\text{ V}$; $t_{GP}=500\text{ }\mu\text{s}$; $di_G/dt=1\text{ A}/\mu\text{s}$
			44.0 51.0	$T_j=T_{j\text{ max}}$ $T_j=25\text{ }^\circ\text{C}$ 180° half-sine wave; $t_p=8.3\text{ ms}$; single pulse; $V_D=V_R=0\text{ V}$; Gate pulse: $I_G=2\text{ A}$; $V_G=20\text{ V}$; $t_{GP}=500\text{ }\mu\text{s}$; $di_G/dt=1\text{ A}/\mu\text{s}$
I^2t	Safety factor	$\text{A}^2\text{s}\cdot 10^3$	8800 11500	$T_j=T_{j\text{ max}}$ $T_j=25\text{ }^\circ\text{C}$ 180° half-sine wave; $t_p=10\text{ ms}$; single pulse; $V_D=V_R=0\text{ V}$; Gate pulse: $I_G=2\text{ A}$; $V_G=20\text{ V}$; $t_{GP}=500\text{ }\mu\text{s}$; $di_G/dt=1\text{ A}/\mu\text{s}$
			8000 10700	$T_j=T_{j\text{ max}}$ $T_j=25\text{ }^\circ\text{C}$ 180° half-sine wave; $t_p=8.3\text{ ms}$; single pulse; $V_D=V_R=0\text{ V}$; Gate pulse: $I_G=2\text{ A}$; $V_G=20\text{ V}$; $t_{GP}=500\text{ }\mu\text{s}$; $di_G/dt=1\text{ A}/\mu\text{s}$
BLOCKING				
V_{DRM}, V_{RRM}	Repetitive peak off-state and Repetitive peak reverse voltages	V	1000...1800	$T_{j\text{ min}} < T_j < T_{j\text{ max}}$; 180° half-sine wave; 50 Hz; Gate open
V_{DSM}, V_{RSM}	Non-repetitive peak off-state and Non-repetitive peak reverse voltages	V	1100...1900	$T_{j\text{ min}} < T_j < T_{j\text{ max}}$; 180° half-sine wave; single pulse; Gate open
V_D, V_R	Direct off-state and Direct reverse voltages	V	$0.6\cdot V_{DRM}$ $0.6\cdot V_{RRM}$	$T_j=T_{j\text{ max}}$; Gate open
TRIGGERING				
I_{FGM}	Peak forward gate current	A	8	$T_j=T_{j\text{ max}}$
V_{RGM}	Peak reverse gate voltage	V	5	
P_G	Gate power dissipation	W	4	$T_j=T_{j\text{ max}}$ for DC gate current
SWITCHING				
$(di_T/dt)_{\text{crit}}$	Critical rate of rise of on-state current non-repetitive ($f=1\text{ Hz}$)	$\text{A}/\mu\text{s}$	630	$T_j=T_{j\text{ max}}$; $V_D=0.67\cdot V_{DRM}$; $I_{TM}=2200\text{ A}$; Gate pulse: $I_G=2\text{ A}$; $V_G=20\text{ V}$; $t_{GP}=50\text{ }\mu\text{s}$; $di_G/dt=2\text{ A}/\mu\text{s}$
THERMAL				
T_{stg}	Storage temperature	$^\circ\text{C}$	-40...+50	
T_j	Operating junction temperature	$^\circ\text{C}$	-40...+130	
$T_{c\text{ op}}$	Operating temperature	$^\circ\text{C}$	-40...+125	
MECHANICAL				
a	Acceleration under vibration	m/s^2	50	

CHARACTERISTICS

Symbols and parameters		Units	Values	Conditions	
ON-STATE					
V_{TM}	Peak on-state voltage, max	V	1.45	$T_j=25\text{ }^\circ\text{C}; I_{TM}=2500\text{ A}$	
$V_{T(TO)}$	On-state threshold voltage, max	V	0.834	$T_j=T_{j\text{ max}};$	
r_T	On-state slope resistance, max	m Ω	0.187	$0.5\pi I_{TAV} < I_T < 1.5\pi I_{TAV}$	
I_L	Latching current, max	mA	1500	$T_j=25\text{ }^\circ\text{C}; V_D=12\text{ V};$ Gate pulse: $I_G=I_{FGM}; V_G=20\text{ V};$ $t_{GP}=500\text{ }\mu\text{s}; di_G/dt=1\text{ A}/\mu\text{s}$	
I_H	Holding current, max	mA	300	$T_j=25\text{ }^\circ\text{C};$ $V_D=12\text{ V};$ Gate open	
BLOCKING					
I_{DRM}, I_{RRM}	Repetitive peak off-state and Repetitive peak reverse currents, max	mA	150 4.00	$T_j=T_{j\text{ max}}$ $T_j=25\text{ }^\circ\text{C}$	$V_D=V_{DRM}; V_R=V_{RRM}$
$(dv_D/dt)_{crit}$	Critical rate of rise of off-state voltage ¹⁾ , min	V/ μs	200, 320, 500, 1000, 1600, 2000, 2500	$T_j=T_{j\text{ max}};$ $V_D=0.67\cdot V_{DRM};$ Gate open	
TRIGGERING					
V_{GT}	Gate trigger direct voltage, max	V	3.00 2.50 1.50	$T_j= T_{j\text{ min}}$ $T_j=25\text{ }^\circ\text{C}$ $T_j= T_{j\text{ max}}$	$V_D=12\text{ V}; I_D=3\text{ A};$ Direct gate current
I_{GT}	Gate trigger direct current, max	mA	400 250 150	$T_j= T_{j\text{ min}}$ $T_j= 25\text{ }^\circ\text{C}$ $T_j= T_{j\text{ max}}$	
V_{GD}	Gate non-trigger direct voltage, min	V	0.50	$T_j=T_{j\text{ max}};$ $V_D=0.67\cdot V_{DRM};$	
I_{GD}	Gate non-trigger direct current, min	mA	80.00	Direct gate current	
SWITCHING					
t_{gd}	Delay time, max	μs	0.90	$T_j=25\text{ }^\circ\text{C}; V_D=1000\text{ V}; I_{TM}=I_{TAV};$ $di/dt=200\text{ A}/\mu\text{s};$	
t_{gt}	Turn-on time, max	μs	2.00	Gate pulse: $I_G=2\text{ A}; V_G=20\text{ V};$ $t_{GP}=50\text{ }\mu\text{s}; di_G/dt=2\text{ A}/\mu\text{s}$	
t_q	Turn-off time ²⁾ , max	μs	250	$dv_D/dt=50\text{ V}/\mu\text{s}; T_j=T_{j\text{ max}}; I_{TM}= I_{TAV};$ $di_R/dt=-10\text{ A}/\mu\text{s}; V_R=100\text{ V};$ $V_D=0.67\cdot V_{DRM}$	
Q_{rr}	Total recovered charge, max	μC	3140	$T_j= T_{j\text{ max}}; I_{TM}=I_{TAV};$	
t_{rr}	Reverse recovery time, max	μs	33	$di_R/dt=-10\text{ A}/\mu\text{s};$	
I_{rr}	Reverse recovery current, max	A	190	$V_R=100\text{ V}$	
THERMAL					
R_{thjc}	Thermal resistance, junction to case			180° half-sine wave, 50 Hz	
	per module	$^\circ\text{C}/\text{W}$	0.0400		
R_{thch}	Thermal resistance, case to heatsink				
	per module	$^\circ\text{C}/\text{W}$	0.0100		
INSULATION					
V_{ISOL}	Insulation test voltage	kV	3.00	Sine wave, 50 Hz; RMS	t=60 sec
			3.60		t=1 sec
MECHANICAL					
M_1	Mounting torque (M6) ³⁾	Nm	6.00	Tolerance $\pm 15\%$	
M_2	Terminal connection torque (M12) ³⁾	Nm	18.00	Tolerance $\pm 15\%$	
m	Weight, max	g	2250		

PART NUMBERING GUIDE

MT	1	-	830	-	18	-	A2	M2	-	E	-	N
1	2		3		4		5	6		7		8

1. MT - Thyristor module
2. Circuit Schematic
3. Average On-state Current, A
4. Voltage Code
5. Critical rate of rise of off-state voltage
6. Group of turn-off time ($dv_D/dt=50 \text{ V}/\mu\text{s}$)
7. Package Type (M.E)
8. Ambient Conditions:
N – Normal

NOTES

1) Critical rate of rise of off-state voltage

Symbol of Group	P2	K2	E2	A2	T1	P1	M1
$(dv_D/dt)_{crit}, \text{ V}/\mu\text{s}$	200	320	500	1000	1600	2000	2500

2) Turn-off time ($dv_D/dt=50 \text{ V}/\mu\text{s}$)

Symbol of Group	M2
$t_{q}, \mu\text{s}$	250

3) The screws must be lubricated

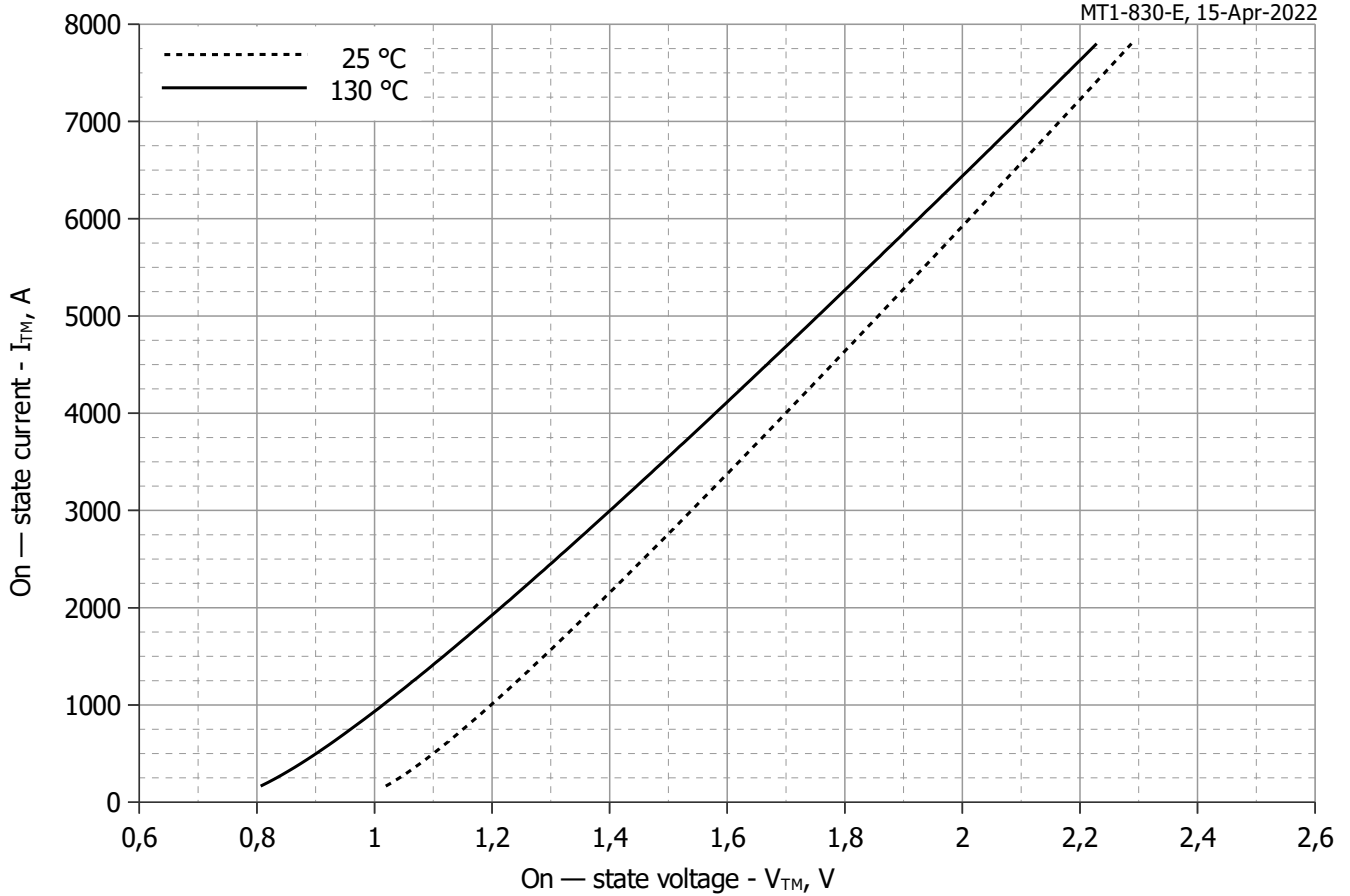

Fig 1 – On-state characteristics of Limit device

Analytical function for On-state characteristic:

$$V_T = A + B \cdot i_T + C \cdot \ln(i_T + 1) + D \cdot \sqrt{i_T}$$

	Coefficients for max curves	
	$T_j = 25^\circ\text{C}$	$T_j = T_{j,max}$
A	0.90469699	0.68656477
B	0.00013781	0.00014390
C	0.01227296	0.00910248
D	0.00224272	0.00382829

On-state characteristic model (see Fig. 1)

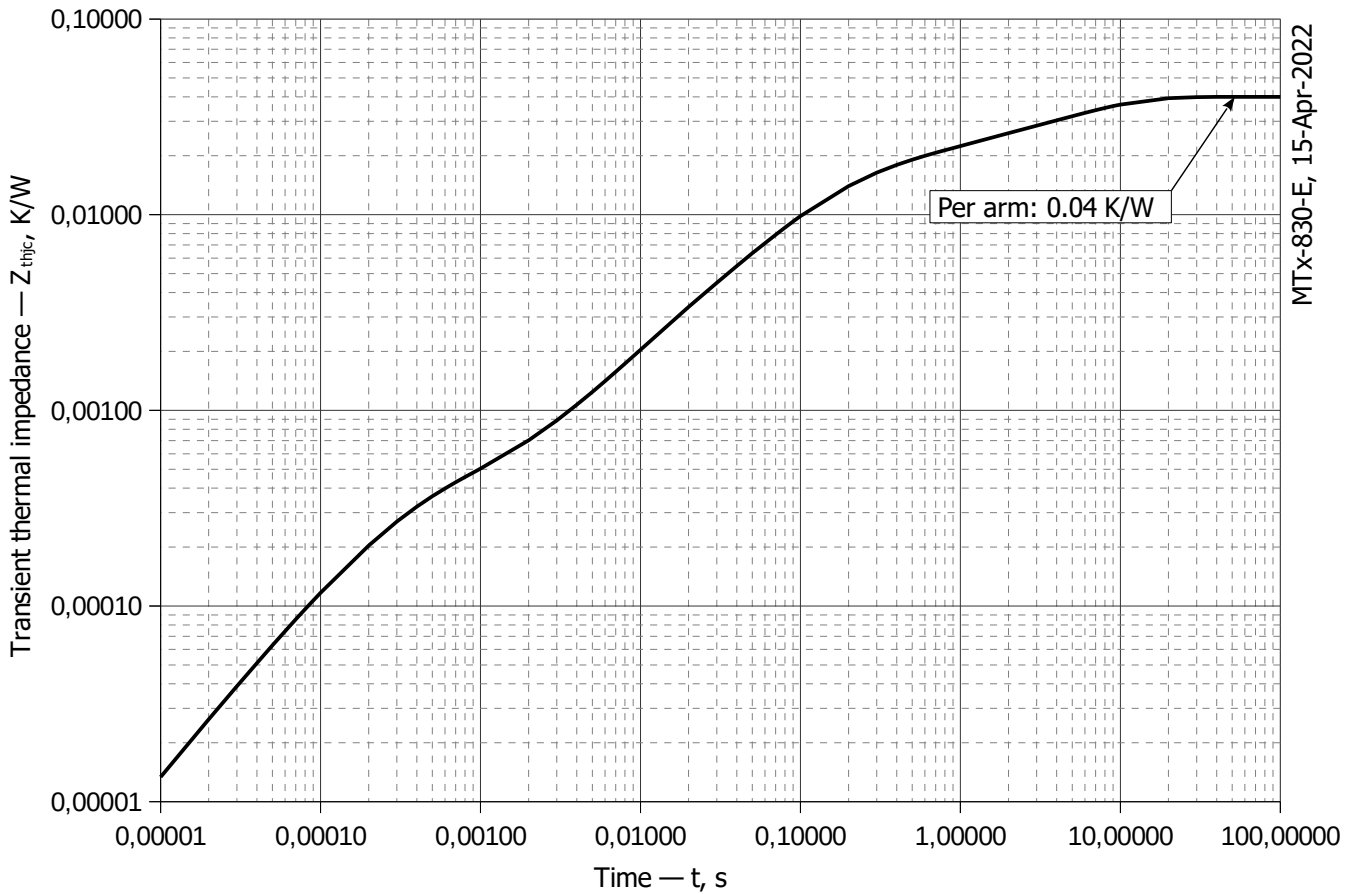

Fig 2 – Transient thermal impedance

Analytical function for Transient thermal impedance junction to case Z_{thjc} for DC:

$$Z_{thjc} = \sum_{i=1}^n R_i \left(1 - e^{-\frac{t}{\tau_i}} \right)$$

Where $i = 1$ to n , n is the number of terms in the series.

t = Duration of heating pulse in seconds.

Z_{thjc} = Thermal resistance at time t .

R_i = Amplitude of p_{th} term.

τ_i = Time constant of r_{th} term.

i	1	2	3	4	5	6
$R_i, K/W$	0.02251	0.005931	0.009502	0.004252	0.001006	0.0003132
τ_i, s	5.887	0.7389	0.1616	0.08215	0.01267	0.0002712

Transient thermal impedance junction to case Z_{thjc} model (see Fig. 2)

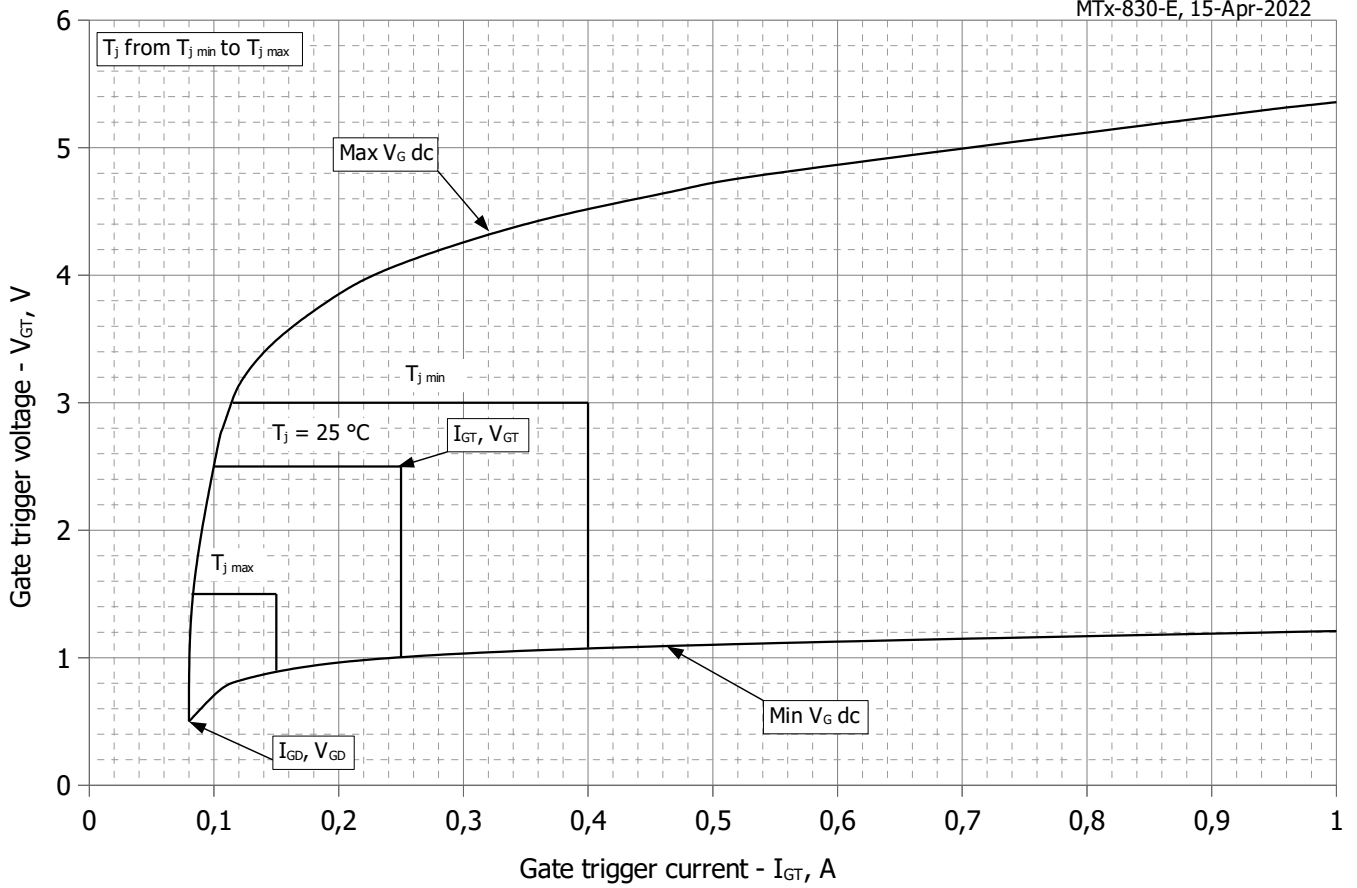

Fig 3 – Gate characteristics – Trigger limits

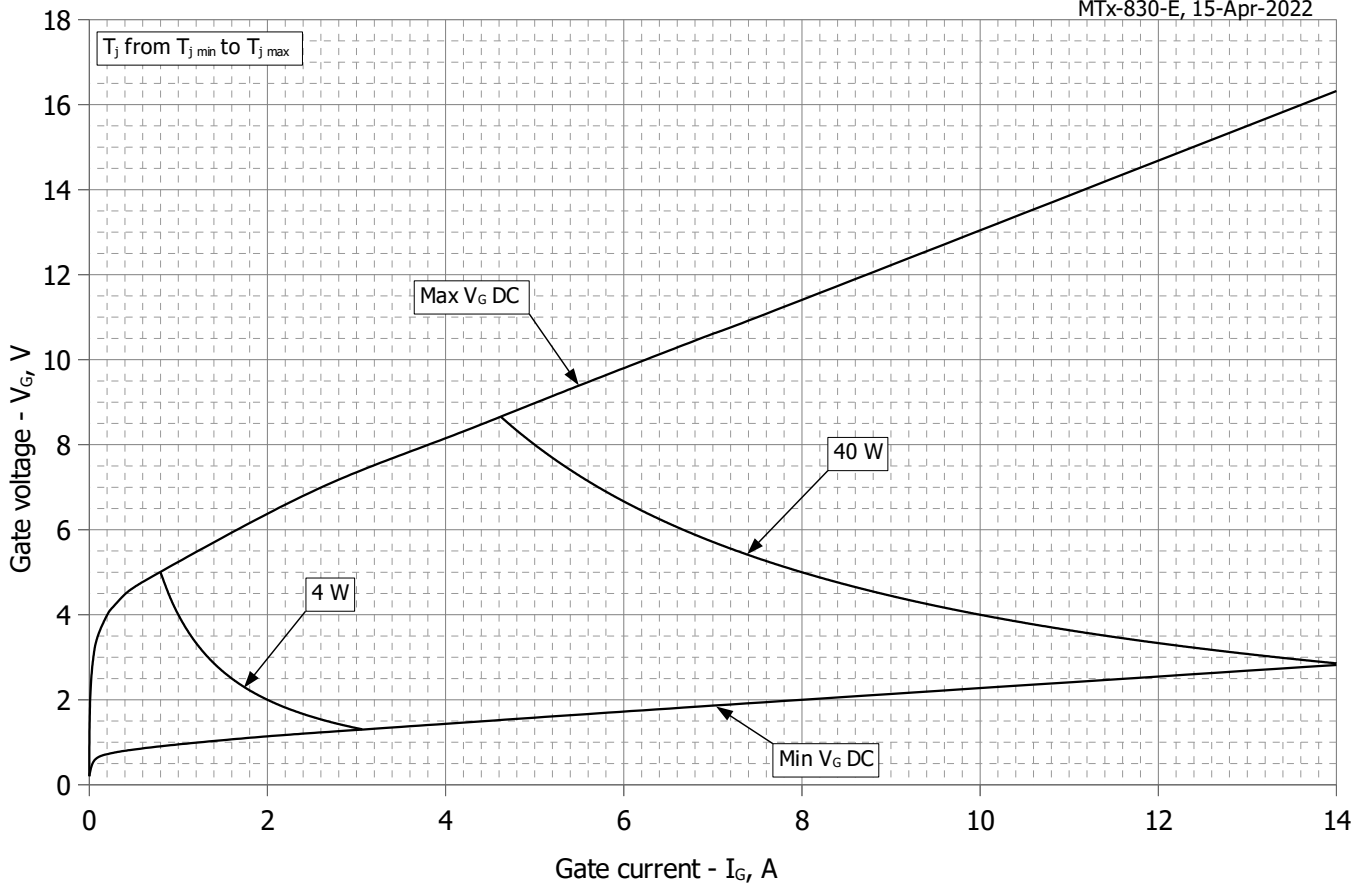

Fig 4 - Gate characteristics – Power curves

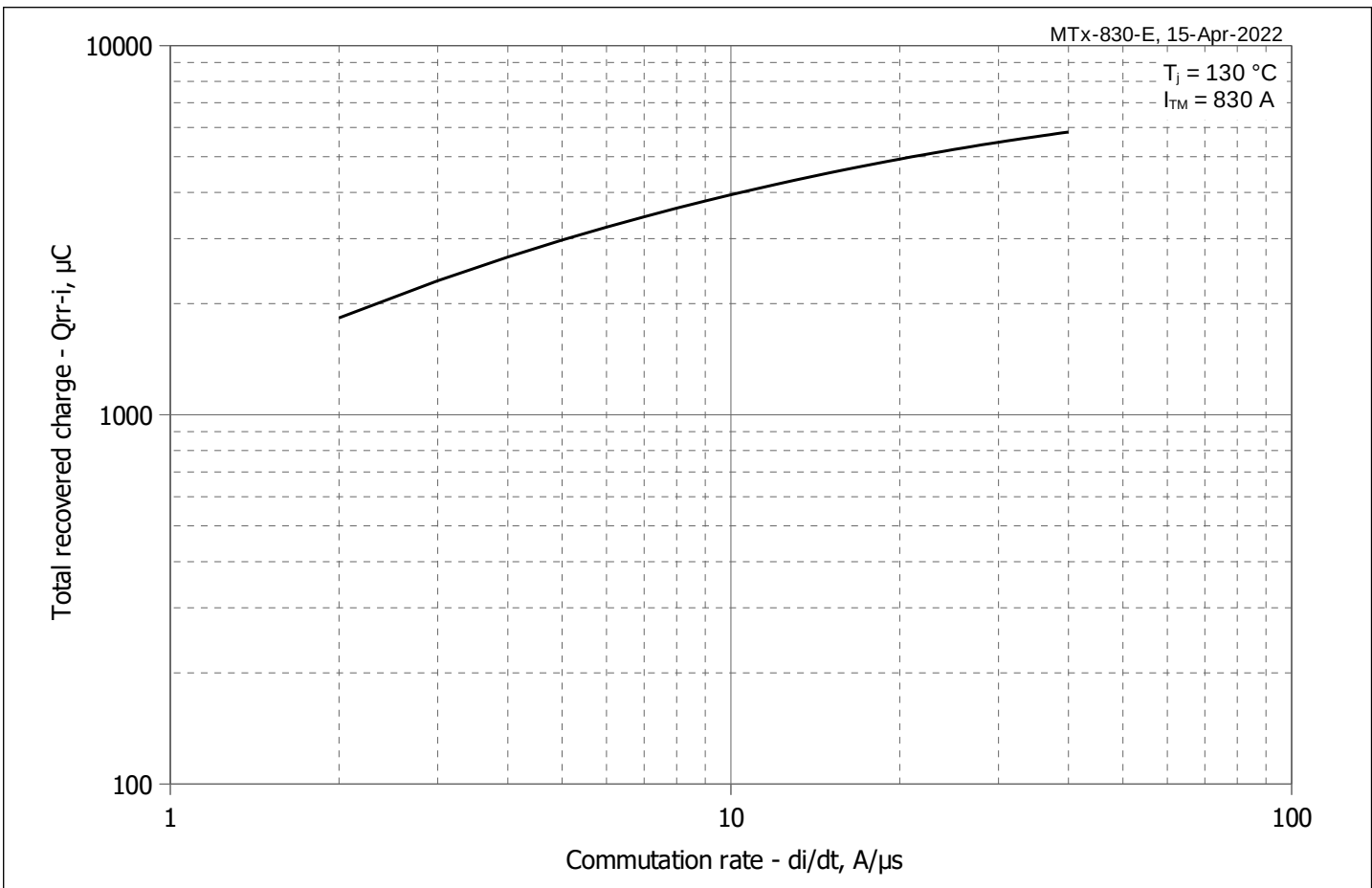

Fig 5 - Total recovered charge Q_{rr-i} (integral) vs. commutation rate di_R/dt

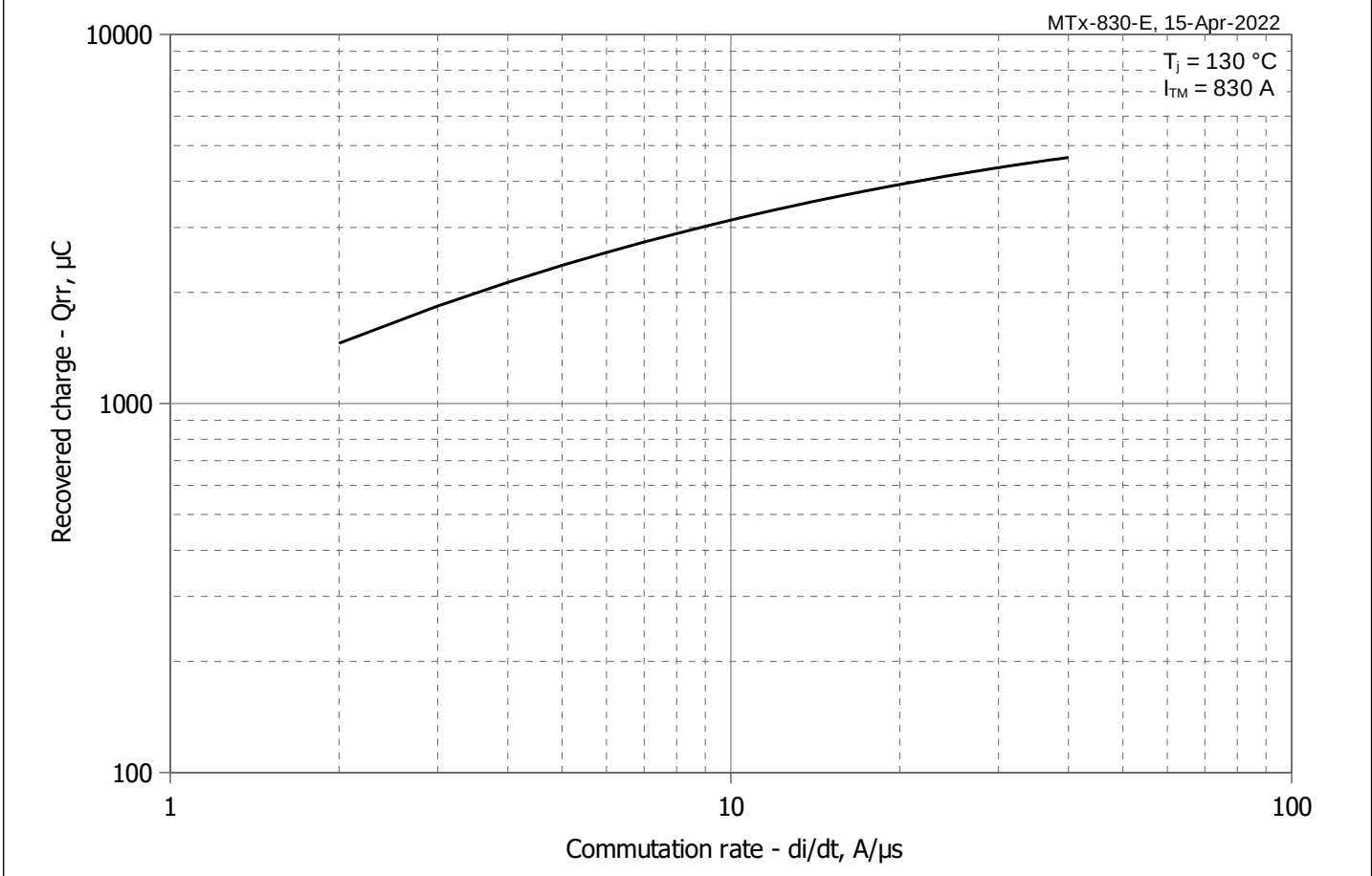

Fig 6 - Maximum recovered charge Q_{rr} vs. commutation rate di_R/dt (25% chord)

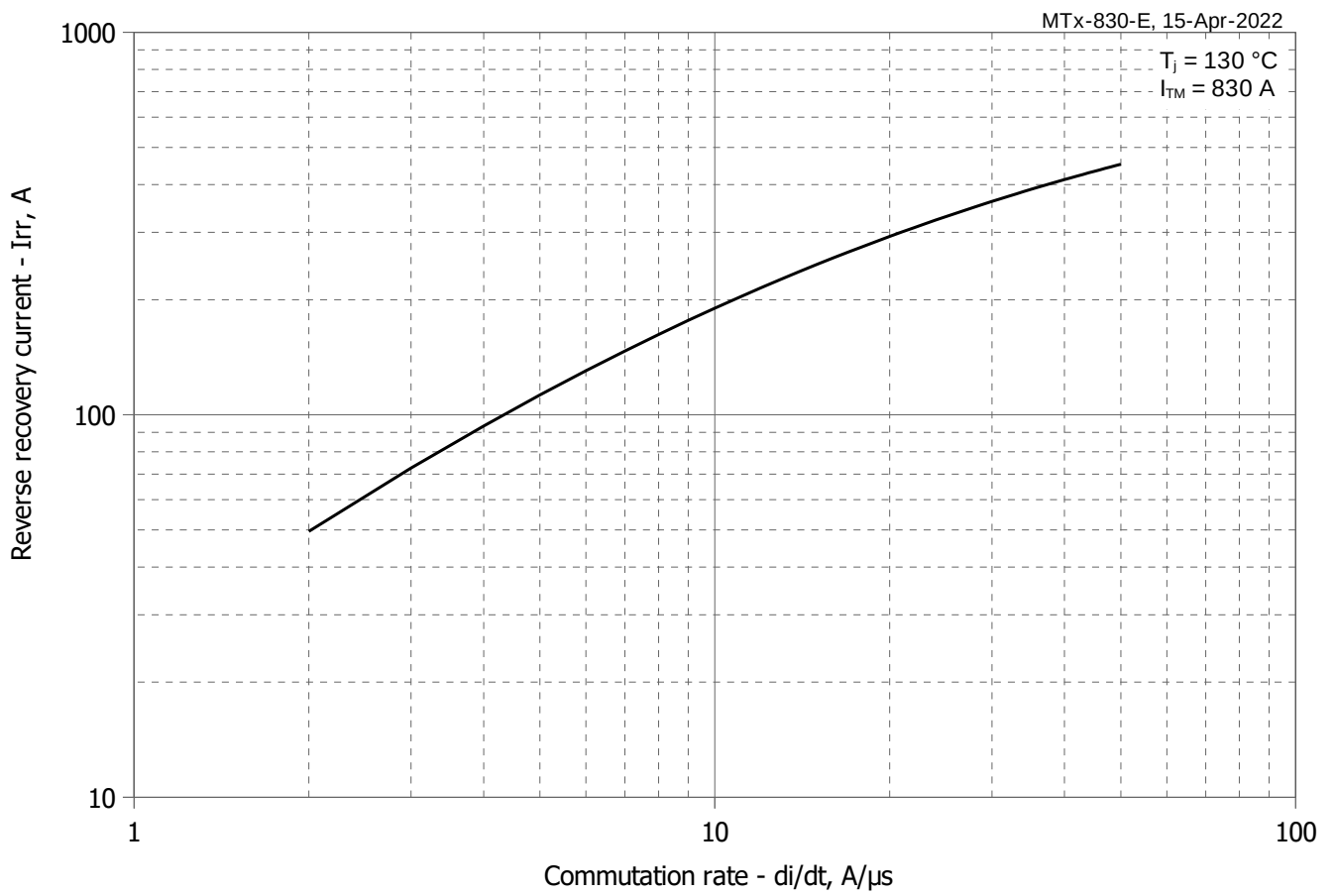

Fig 7 - Maximum reverse recovery current I_{rr} vs. commutation rate di_R/dt

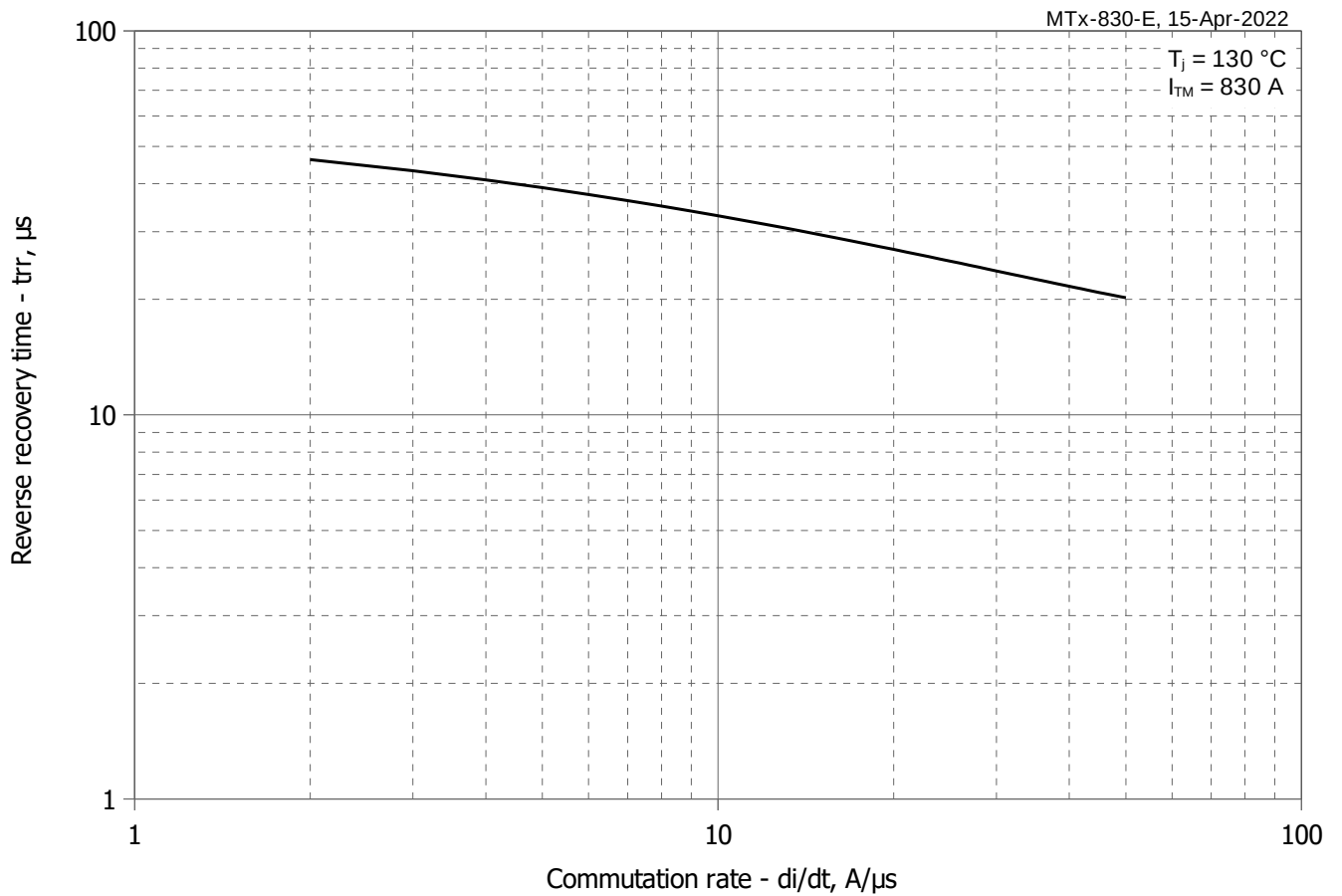

Fig 8 - Maximum recovery time t_r vs. commutation rate di_R/dt (25% chord)

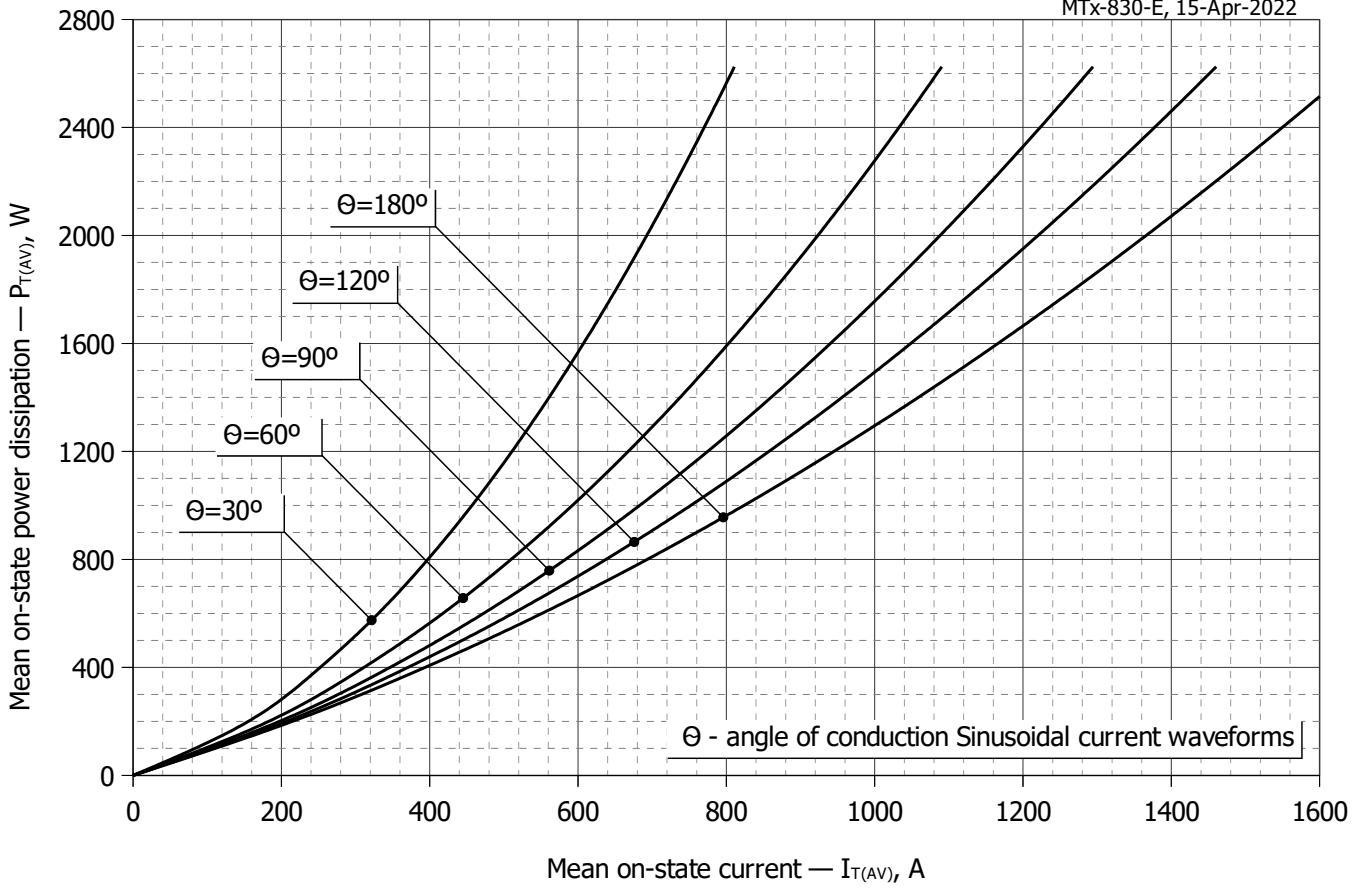

Fig. 9 - Mean on-state power dissipation P_{TAV} vs. mean on-state current I_{TAV} for sinusoidal current waveforms at different conduction angles ($f=50\text{Hz}$)

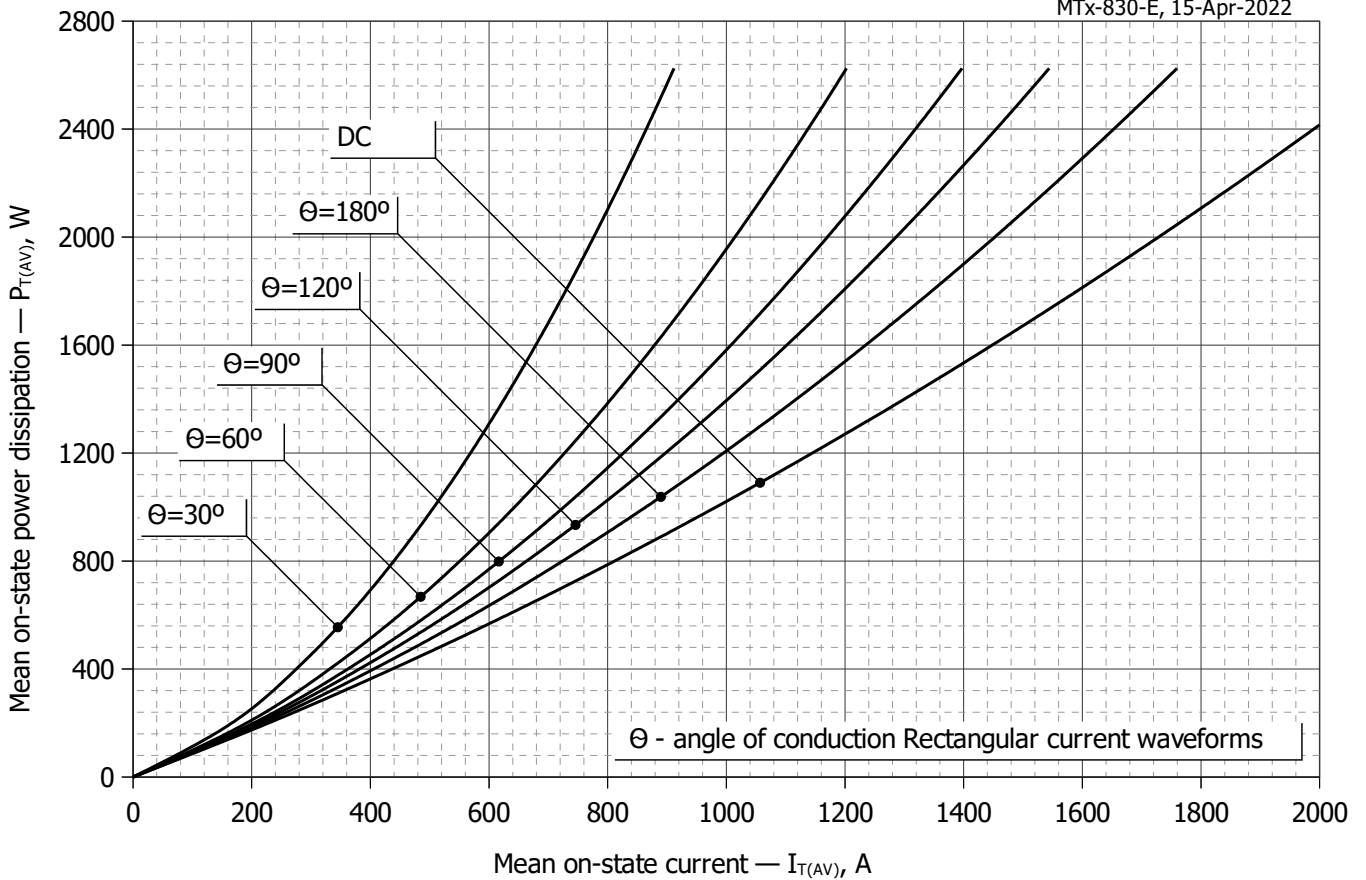

Fig. 10 - Mean on-state power dissipation P_{TAV} vs. mean on-state current I_{TAV} for rectangular current waveforms at different conduction angles and for DC ($f=50\text{Hz}$)

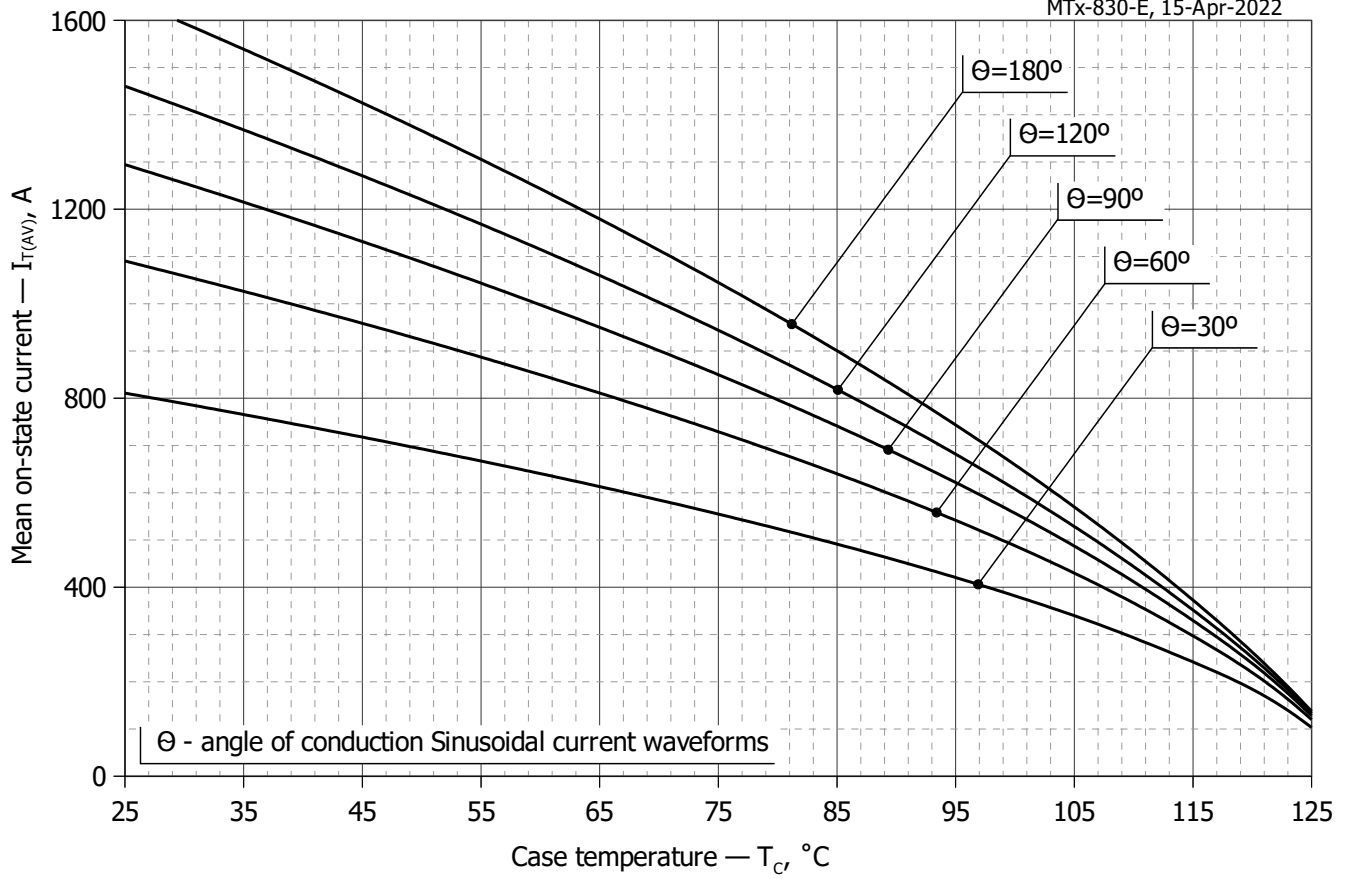

Fig. 11 – Mean on-state current I_{TAV} vs. case temperature T_C for sinusoidal current waveforms at different conduction angles ($f=50Hz$)

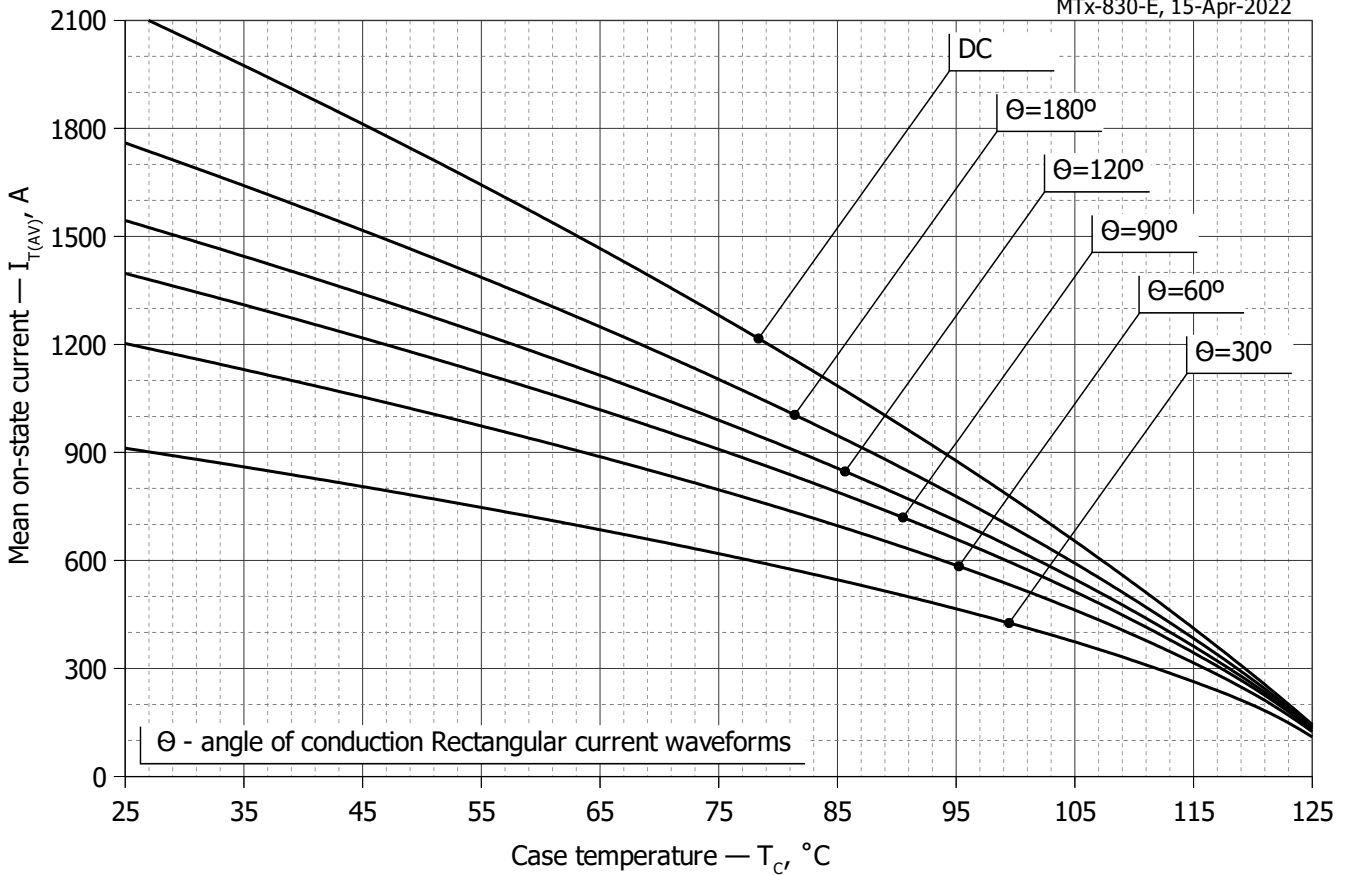

Fig. 12 - Mean on-state current I_{TAV} vs. case temperature T_C for rectangular current waveforms at different conduction angles and for DC ($f=50Hz$)

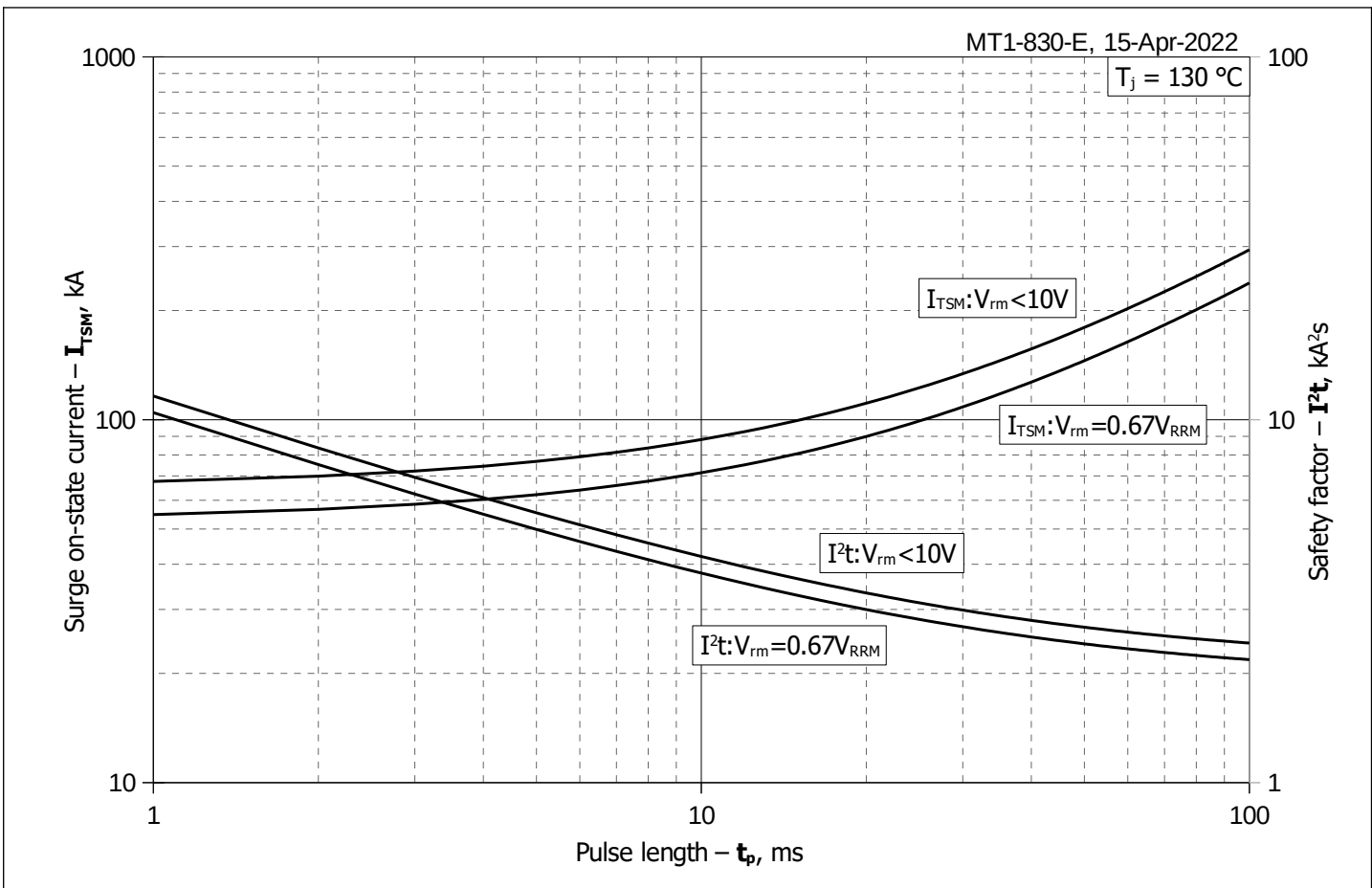

Fig. 13 – Maximum surge on-state current I_{TSM} and safety factor I^2t vs. pulse length t_p

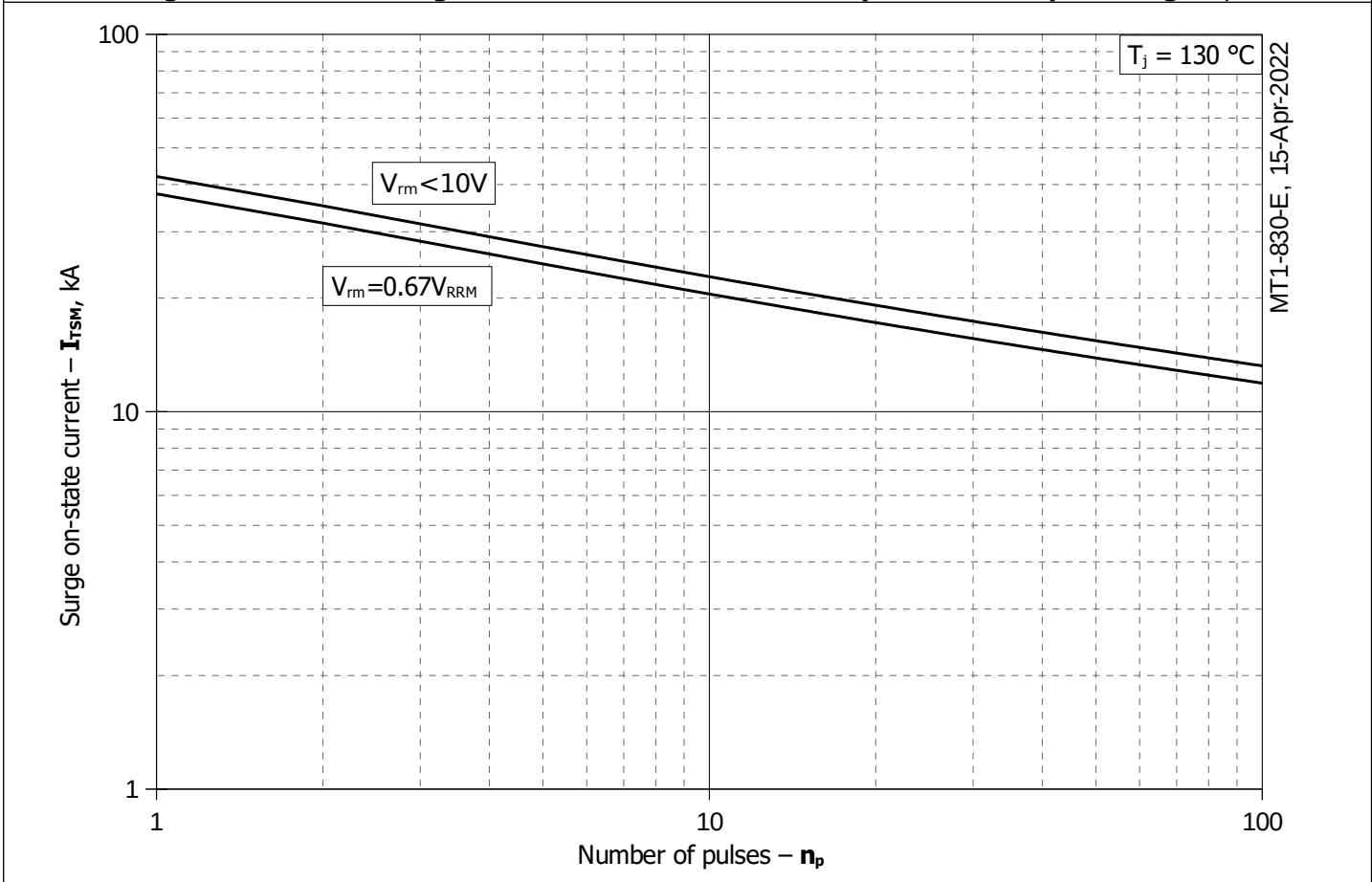

Fig. 14 - Maximum surge on-state current I_{TSM} vs. number of pulses n_p